



# LightSYS Plus

## Quick Installer Guide

See the *LightSYS Plus Installation and Programming Manual* at [www.riscogroup.com](http://www.riscogroup.com) for additional, detailed information.



For more information about RISCO Group's branches, distributors and full product line, please visit [riscogroup.com](http://riscogroup.com)

# Contents

<b>INTRODUCTION .....</b>	<b>6</b>
<b>GETTING STARTED .....</b>	<b>6</b>
<b>Main Steps for Initial System Setup.....</b>	<b>6</b>
<b>IMPORTANT SAFETY PRECAUTIONS.....</b>	<b>7</b>
<b>INSTALLATION .....</b>	<b>8</b>
<b>Step 1: Creating a Plan for Mounting the System .....</b>	<b>8</b>
Main Panel Mounting Guidelines.....	8
<b>Step 2: Wiring, Settings, and Module Installations at the Main Panel .....</b>	<b>8</b>
Power Supply, Ground Wiring and Telephone Wiring .....	8
Main Panel Wiring Diagram .....	10
Replacing the Main Panel PCB .....	11
Main Panel Initial Settings .....	11
Installing Plug-In Communication & Audio Modules .....	12
Installing a GSM Module .....	12
Installing a SIM Card.....	12
Connecting to IP.....	12
Connecting to Wi-Fi.....	12
Installing an LRT Module .....	12
Installing the Voice Module .....	12
Installing the Listen-In Unit .....	13
Wiring other Devices at the Terminal Block.....	13
<b>Installing a Wired Keypad .....</b>	<b>13</b>
Connecting Auxiliary (12 V DC) Devices .....	13
Connecting the Bell / Loudspeaker .....	14
Connecting the Bell Tamper.....	14
Connecting Utility Output 1 .....	14
<b>Step 3: Bus Line Installations .....</b>	<b>15</b>
Bus Line Wiring .....	15
Describing Bus Devices .....	15
Describing Bus Detectors and their Connection Options.....	15
Wired Expansion Modules Installed on RISCO Bus Lines .....	16

Describing Installer-Set ID Numbers for Bus Devices .....	17
ID Number Formats .....	18
Assigning ID Numbers (Setting DIP Switches) for Bus Devices .....	19
Installing Bus Devices .....	20
Installing Wired Keypads .....	20
Connecting Individual Bus Detectors to a Bus at the Main Panel .....	20
Connecting Multiple Bus Detectors using Bus Zone Expanders .....	21
<b>Step 4: Connecting Relay Detectors .....</b>	<b>22</b>
Defining Zone Termination Resistance.....	22
Wiring Resistors for Zone Termination Resistance.....	23
Zone Termination Configuration Options.....	23
<b>Step 5: Connecting the Backup Battery and Mounting the Main Panel .....</b>	<b>24</b>
Connecting the Backup Battery.....	24
Mounting the Main Panel.....	24
<b>SYSTEM INITIALIZATION, DEVICE ALLOCATION, GENERAL SYSTEM CONFIGURATION .....</b>	<b>25</b>
<b>Step 1: Working with the Keypad and Installer Menus .....</b>	<b>25</b>
Describing Dynamic Keypad Menus .....	25
Table of Menu Navigational Keys .....	25
Designating Labels .....	25
Entering the Installer Programming Menu at Initial System Setup .....	26
<b>Step 2: Powering-Up and Initializing the System .....</b>	<b>26</b>
Initial System Power-Up and Language Selection .....	26
Defining Partitions after Initialization .....	26
<b>Step 3: Allocating and Configuring Installed Components .....</b>	<b>27</b>
Auto-Setting Allocation of Communication Modules and Bus Devices.....	27
Describing Auto-Setting Results .....	28
Performing a Bus Test .....	28
Manually Allocating & Configuring Communication Modules .....	29
GSM Modules .....	29
Entering or Deleting a SIM Card PIN .....	29
Defining APN Automatically and Manually.....	30
IP/Wi-Fi Modules.....	30
Setting Dynamic IP / Static IP.....	30
Long-Range Radio Transmitter Module.....	30

Manually Allocating & Configuring other Modules and Bus Devices .....	31
Wired Keypads .....	31
Zone Expanders .....	32
Utility Output Modules .....	32
Power Supply Modules .....	32
Wireless Expanders .....	33
Proximity Key Readers .....	33
Voice Module .....	34
Sounders (Sirens) .....	34
Bus Zones (Bus Detectors) .....	35
Bus Zone Expanders .....	35
<b>Step 4: Allocating Wireless Zones .....</b>	<b>36</b>
Allocating Wireless Expanders .....	36
Allocating Wireless Devices .....	36
Sending Wireless Device RF Transmissions .....	37
<b>Step 5: Basic Zone Configuration for All Zone Types .....</b>	<b>38</b>
Defining Basic Parameters .....	38
Describing Zone Information Displayed at the Keypad .....	38
Defining Zone Parameters using the “One-By-One” Option .....	39
Defining Zone Parameters using the “By Category” Option .....	40
Defining Zone Termination Resistance using the “Resistance” Option .....	40
Zone Termination Resistance Values (in Ohms) .....	41
<b>Step 6: Advanced Zone Configuration for Bus Zones and Wireless Zones .....</b>	<b>41</b>
Advanced Programming for Bus Zones .....	41
Advanced Programming for Wireless Zones .....	42
Measuring Background Noise Level and Defining its Threshold Limit .....	42
Performing a Wireless Comm. Test for Measuring Signal Strength .....	43
<b>Step 7: Configuring System Communication .....</b>	<b>44</b>
Defining Primary Communication Channels & Parameters .....	44
Defining Communication with the Monitoring Station .....	45
Enabling Monitoring Station Communication .....	45
Defining Monitoring Station Account Parameters .....	45
<b>Step 8: Configuring Cloud Connectivity .....</b>	<b>46</b>
Enabling / Disabling Cloud Communication .....	46
Defining RISCO Cloud Connectivity .....	46



- Step 9: Configuring Common System Parameters.....47**
  - Defining System Users ..... 47
    - Defining User Codes ..... 47
    - Changing the Default Installer Code..... 47
    - Changing the Default Grand Master Code ..... 48
  - Defining Follow Me Destinations ..... 48
    - Enabling Follow Me ..... 48
    - Defining Follow Me Parameters ..... 48
  - Defining System Timers..... 48
- INSTALLER PROGRAMMING ..... 49**
  - Step 1: Defining Additional Parameters in the Installer Programming Menu .....49**
  - Step 2: Exiting Installer Programming Menu after Initial System Configuration.....49**
  - Step 3: Defining Parameters in other Installer Menus .....49**
- TESTING THE SYSTEM ..... 50**
- INSTALLER RESPONSIBILITIES FOR ASSISTING CLIENTS ..... 50**
- TECHNICAL SPECIFICATION ..... 51**

## Introduction

LightSYS Plus is a Grade 3 compatible, super-hybrid security system that offers communication flexibility and advanced system control via Smartphone and Web user apps, scalable up to 512 zones. The LightSYS Plus system can also be divided to up to 32 partitions and any zone can be associated to any partition.

## Getting Started

This guide covers the main tasks required to install and set up the LightSYS Plus system. Installation and setup should be performed by a professional alarm system installer. For additional comprehensive details, refer to the *LightSYS Plus Installation and Programming Manual*.

## Main Steps for Initial System Setup

### INSTALLATION

- Step 1: Creating a Plan for Mounting the System
- Step 2: Wiring, Settings, and Module Installations at the Main Panel
- Step 3: Bus Line Installations
- Step 4: Connecting Relay Detectors
- Step 5: Connecting the Backup Battery and Mounting the Main Panel

### SYSTEM INITIALIZATION, DEVICE ALLOCATIONS & GENERAL SYSTEM CONFIGURATION

- Step 1: Working with the Keypad and Installer Menus
- Step 2: Powering-Up and Initializing the System
- Step 3: Allocating and Configuring Installed Components
- Step 4: Allocating Wireless Zones
- Step 5: Basic Zone Configuration for All Zone Types
- Step 6: Advanced Zone Configuration for Bus Zones and Wireless Zones
- Step 7: Configuring System Communication
- Step 8: Configuring Cloud Connectivity
- Step 9: Configuring Common System Parameters







### INSTALLER PROGRAMMING

- Step 1: Defining Additional Parameters in the Installer Programming Menu
- Step 2: Exiting Installer Programming Menu after Initial System Configuration
- Step 3: Defining Parameters in other Installer Menus

### TESTING THE SYSTEM

### INSTALLER RESPONSIBILITIES FOR ASSISTING THE CLIENT

## Important Safety Precautions

-  **WARNING:** Installation or usage of this product that is not in accordance with the intended use and manufacturer instructions can result in damage, injury or death. The system is NOT meant to be installed or serviced by those other than professional security alarm system installers.
-  **WARNING:** Make sure this product is not accessible by those for whom operation of the system is not intended, such as children.
-  **WARNING:** The main panel should be connected to an easily-accessible wall outlet so that power can be disconnected immediately in case of malfunction or hazard. If it is permanently connected to an electrical power supply, then the connection should include an easily-accessible disconnection device, such as a circuit breaker.
-  **WARNING:** Coming into contact with 230 VAC can result in death. If the main panel is open while it is connected to the electrical power supply, do not touch any AC electrical wiring to/from the mains fuse terminals nor the mains fuse terminals.
-  **WARNING:** Ensure proper grounding requirements are implemented for the system and peripherals, where required.
-  **WARNING:** Replace battery with correct type to avoid the risk of explosion.
-  **CAUTION:** Dispose of batteries according to applicable law and regulation.

## Installation

### Step 1: Creating a Plan for Mounting the System

**NOTE:** For main panel installation, see the box/enclosure instructions. See the *LightSYS Plus Installation and Programming Manual* for wireless system mounting considerations.

#### Main Panel Mounting Guidelines

Before you mount the main panel and peripheral components, make a plan for obtaining the most optimal location for the panel, which (depending on configuration-specific requirements) should typically be:

- Centrally located for minimizing lengthy bus line/expansion module wire runs
- In a location with good GSM reception
- In a secure location that is hidden and not reachable by those for whom use is unintended (such as small children)
- Near an uninterrupted 230 VAC electrical outlet, an easily accessible disconnection device such as a circuit breaker (if permanently connected to the electrical power supply), grounding connection, and network cable outlet, as needed
- In a dry place, away from sources of electrical and RF disturbance, and not near large metal objects which may hinder reception

### Step 2: Wiring, Settings, and Module Installations at the Main Panel

#### Power Supply, Ground Wiring and Telephone Wiring

- **IMPORTANT:** AC wiring should be performed by a certified electrician, and in compliance with applicable electrical code, laws and regulation. See the *LightSYS Plus Installation and Programming Manual* and the box/enclosure instructions. The electrical power rating is specified on the label located next to the fuse.
- The main panel should be connected to an easily accessible wall outlet so that electrical power can be disconnected immediately in case of malfunction or hazard. If it is permanently connected to an electrical power supply, then the connection should include an easily accessible disconnection device, such as a circuit breaker



## ⚠ WARNINGS:

- To prevent risk of electric shock, **do not** apply electrical power to the main panel nor connect the main panel's backup battery at any time during installation or servicing. The panel is not to be powered up until system initialization (*Step 2: Powering-Up and Initializing the System, page 26*).
- Under no circumstances should a mains power cable be connected to the main panel/PCB other than to the mains fuse terminal block.
- Replace the fuse only with one of the same type and rating (250 V, 3.15 A).

### ➤ To connect the power supply and ground wiring:

1. Do not connect AC power at this point of the installation.
2. Refer to the box/enclosure instructions.
3. LightSYS Plus is powered by a RISCO-supplied AC/DC adaptor (100-240V, 50/60Hz, 14.4V, 2.5-4.5A) that is pre-installed inside the main panel box/enclosure. Connection to AC must be permanent and connect through the mains-fuse terminal block as follows:

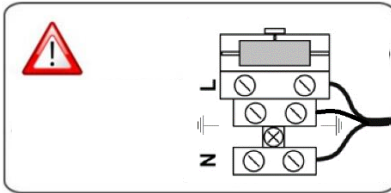

**IMPORTANT:** Clamp power cable wires to the box/enclosure housing using plastic ties, and thread them through the arched tie-down brackets on the base of the box/enclosure housing (see box/enclosure instructions).

**IMPORTANT:** For safety reasons use the fire enclosure, see the *LightSYS Plus Plastic Box Installation Instructions*.



## Replacing the Main Panel PCB

If replacing the main panel PCB (to prevent bus sirens from sounding), before you power-off the main panel, first enter the installer Programming mode. Then you can power-off the main panel and replace the PCB assembly.

### Main Panel Initial Settings

Settings	Operation	Status
<b>1: Bell</b>	From the installer Programming menu, go to: 1 > 5 > 1 > 2 (System > Settings > Siren Mode > Bell), and then press OK (✓).	<b>ON:</b> Bell: For a bell or electronic siren with a built-in siren driver. <b>OFF (Default):</b> For a loudspeaker without a built-in sound driver.
<b>2: Default</b>	<ol style="list-style-type: none"> <li>Using the HandyApp, scan the control panel's ID and note the unique 8-digit reset key that will display.</li> <li>Reset the control panel.</li> <li>From the keypad, press + 8 simultaneously: &lt;Enter reset key:&gt; will display.</li> <li>Enter the reset key and press OK (✓).</li> </ol> <p><b>NOTE:</b> The reset key should be entered within 5 minutes of panel reset.</p>	Intended for installer programming at initial system setup (from the installer Programming menu), this setting allows the installer to set the installer, sub-installer and Grand Master codes.
<b>3: Bell tamper bypass</b>	From the installer Programming menu, go to: 1 > 5 > 8 > 1 (System > Settings > Bypass Tamper > Bell tamper), and then press OK (✓).	<b>ON:</b> Bell tamper protection is bypassed (not active) <b>OFF: (Default):</b> Bell tamper protection is not bypassed (active)
<b>4: Box tamper bypass</b>	From the installer Programming menu, go to: 1 > 5 > 8 > 2 (System > Settings > Bypass Tamper > Box tamper), and then press OK (✓).	<b>ON:</b> Box tamper protection is bypassed (not active) <b>OFF (Default):</b> Box tamper protection is not bypassed (active)
<b>5. Onboard tamper</b>	From the installer Programming menu, go to: 1 > 5 > 8 > 3 (System > Settings > Bypass Tamper > Onboard tamper), and then press OK (✓).	<b>ON:</b> Onboard tamper protection is bypassed (not active) <b>OFF (Default):</b> Onboard tamper protection is not bypassed (active)

## Installing Plug-In Communication & Audio Modules

**⚠ CAUTION:** Before installing any communication or audio module, in order to prevent damage to system components, make sure the main panel is NOT powered up, and that the panel's backup battery is DISCONNECTED.

**NOTE:** See the installation instructions included with each module, and the *Main Panel Wiring Diagram* for module connection locations on the PCB. Also see the *LightSYS Plus Installation and Programming* manual for further details.

### Installing a GSM Module

GSM modules provide voice and data communication over a cellular network. The G2, G3 and G4\* GSM modules provide generation 2 and 3 GSM communication.

- Install according to the instructions packaged with the module.

### Installing a SIM Card

- For GSM communication, install a SIM card in its holder on the GSM module. Later during installer programming, you can enter /disable the PIN and define the APN.

### Connecting to IP

IP modules provide data communication over TCP/IP.

Connect the incoming LAN cable to its jack on the IP onboard. Make sure that the cable is connected to the network.

### Connecting to Wi-Fi

**NOTE:** Your Router's Wi-Fi must be activated for the Control Panel to recognize and communicate with the Router.

1. To connect via Wi-Fi network, you must select your Router's Wi-Fi network.
2. Go to Activities → Wi-Fi screen: available networks appear in a list.
3. Select the desired network and enter the password (if required).

### Installing an LRT Module

A Long-Range (Radio) Transmitter module (LRT) can be installed on a bus line.

- Install according to the manufacturer instructions.

### Installing the Voice Module

- Install according to the instructions packaged with the module.

---

\* G4 GSM does not support voice communication

## Installing the Listen-In Unit

Wired onto the Voice module, the Listen-In units are remote, external audio accessories that provide 2-way “listen-in-and-talk” communication between users at the premises and the monitoring station – for times of emergency.

- Install according to the instructions packaged with the Listen-In unit and the Voice module.

## Wiring other Devices at the Terminal Block

### Installing a Wired Keypad

A wired keypad should be installed first, as it is used to set defaults upon system initialization (language, time and date), to perform an Auto-Setting scan for allocating (registering) all bus-connected devices, and for configuring parameters. Wired keypads can either be connected directly to a bus at the main panel terminal block, or to a RISCO bus line (see *Step 3: Bus Line Installations*, page 15).

### Connecting Auxiliary (12 V DC) Devices

Use the **Auxiliary Power AUX (+) and COM (-)** terminals to power, for example, PIRs, glass-break detectors (4-wire types), smoke detectors, audio switches, photoelectric systems, or any device that requires a 12 V DC power supply.

#### NOTES:

- Maximum current draw for each bus (“AUX RED” terminals) is 500 mA.
- Maximum current from the AUX terminal is 1A.
- Total current draw from the panel terminal blocks should not exceed 2000mA, in addition to above limitations.
- If, at the main panel terminal block, any Bus or AUX outputs are overloaded and are shut down, you must disconnect all loads from those Bus or AUX outputs for a period of at least 10 seconds before you reconnect any load to those outputs.
- To increase your power ability when employing multiple auxiliary devices, you can use an optional Power Supply expansion module(s).
- For 4-wire smoke detectors, see the *LightSYS Plus Installation and Programming Manual* and the packaged installation instructions.
- To prevent a possible drop in voltage due to current requirements and distances involved, make sure to use the appropriate wire gauge (refer to the table of gauge sizes for AUX devices in the *LightSYS Plus Installation and Programming Manual*).

## Connecting the Bell / Loudspeaker

The **Bell & LS** (loudspeaker) terminals provide power to the internal bell (siren).

**NOTE:** A maximum of 500 mA may be drawn from this output.

### > To connect the internal bell (siren):

With main panel power removed, connect the internal bell with the correct polarity (for installation instructions see the *LightSYS Plus Installation and Programming Manual* and the packaged installation instructions).

## Connecting the Bell Tamper

### > To utilize the bell tamper:

- With main panel power removed, connect the bell tamper to the **BELL TMP** and **COM** terminals on the main panel using a 2.2K  $\Omega$  resistor in serial.

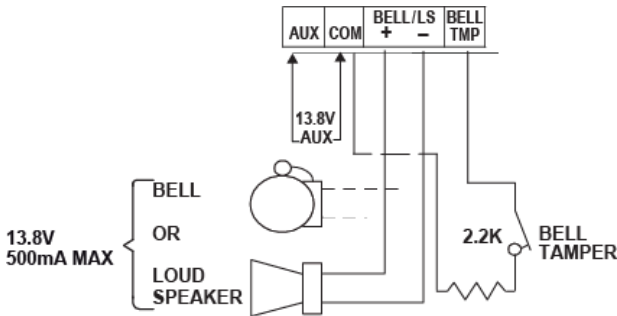

**BELL/LS (+):** To connect to the self activated bell's (SAB) positive hold off input.

**BELL/LS (-):** To connect to the SAB negative hold off input.

**BELL TMP:** To connect to the bell input of the SAB Unit.

## Connecting Utility Output 1

Utility outputs such as UO1 (Utility Output 1) are used to activate external self-powered devices (such as siren):

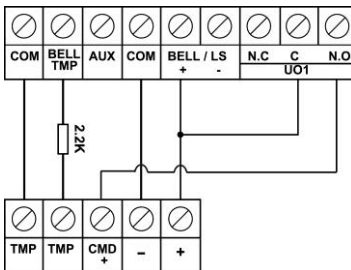



### Step 3: Bus Line Installations

LightSYS Plus supports up to 4 separate, independent RISCO bus lines. If one bus line ever experiences a problem that interrupts data flow (such as being cut or shorted), the other RISCO bus lines will continue operating normally.

#### Bus Line Wiring

On the main panel PCB, the 4 wires of each RISCO bus line (red, black, yellow, green) connect to the respective screw terminals on the terminal block as follows:

Bus screw terminal	Purpose
AUX RED	+12 V DC power
COM BLK	0V common
BUS YEL	Data (yellow wire)
BUS GRN	Data (green wire)

#### Describing Bus Devices

All peripheral devices (bus detectors, keypads, sirens) as well as expansion modules (Single-Zone Expanders, 8-Zone Expanders, Wireless Expanders, Power Supply Expanders, Bus Zone Expanders, Output Expanders) that **connect and communicate to the main panel via bus line** are all referred to as

bus-connected devices, or “bus devices.” Bus devices fall under **categories** pertaining to zones, outputs, power supplies, wired keypads and sirens.

**NOTE:** Even though zone expanders (single-zone and 8-zone) connect relay detectors and not bus detectors, they are bus devices.

#### Describing Bus Detectors and their Connection Options

Connect multiple bus detectors to RISCO bus lines via Bus Zone Expanders (BZEs), which serve to expand the number of bus detectors and also enhance bus security and performance. A smaller number of bus detectors can be connected individually without connecting to Bus Zone Expanders – they are wired to a bus at the main panel PCB (see *Connecting Individual Bus Detectors to a Bus at the Main Panel*, page 20). For installation, refer to the packaged instructions supplied with the bus detector.

## Wired Expansion Modules Installed on RISCO Bus Lines

The following shows different types of wired expansion modules typically installed on a RISCO bus line (all are bus devices). Note that wireless expanders can also be wired to a RISCO bus line.

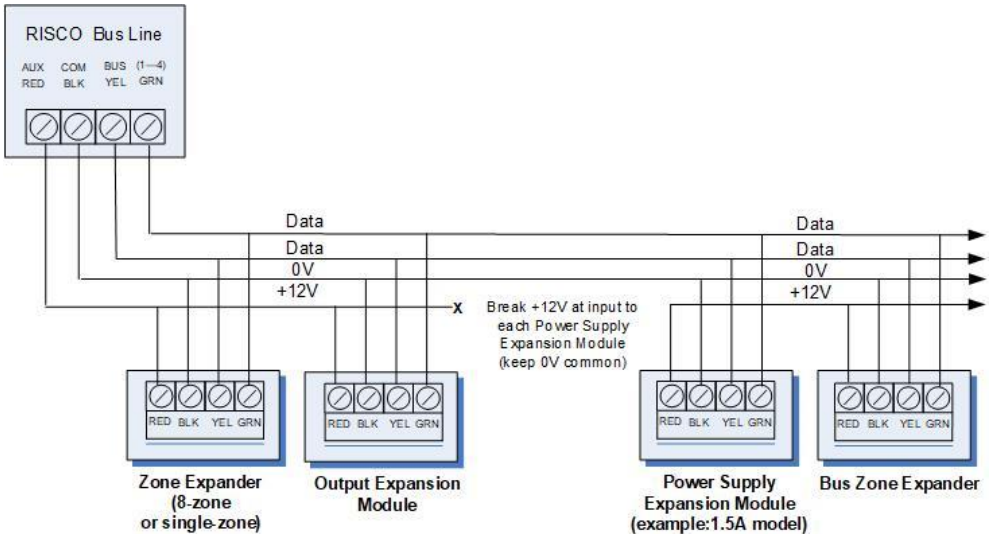

### NOTES:

- The parallel wiring system supports parallel connections from any point along the wiring.
- Maximum wire run permitted is 300 meters (1000 feet) for each leg of a bus line.
- In case of bus communication problems, connect two of the supplied 2.2K  $\Omega$  resistors, with one at each end of the bus data terminals (connecting the green to the yellow terminals).
- For long cable runs, please use the correct cable as stated in the *Wiring Appendix* of the *LightSYS Plus Installation and Programming Manual*.
- If connecting remote power supply units, **do not** connect the red wire (+12 V) between the power supply unit and the LightSYS Plus main panel. Break the +12V at the input to each power supply expansion module (keep 0V common).
- If additional current is required on a bus line, install power supply expansion module(s).



## Describing Installer-Set ID Numbers for Bus Devices

For each bus device category (see table below), each of its respective bus devices gets a sequentially-assigned, installer-set “physical” ID number that the installer physically sets with the device’s DIP switches before powering up the device.

**NOTE:** To be unique, bus devices in the same category that are on the same bus line must have **sequentially different** physical ID numbers, whereas different devices (or the same bus device types on different bus lines) can have the **same** physical ID number.

Categories	Respective bus devices
ZONES	Bus Zone Expanders
	Bus zones (bus detectors)
	Zone expansion modules: Single-Zone Expander, 8-Zone Expander
	Wireless Expander
OUTPUTS	Output expansion modules: (4 outputs/3A)
POWER SUPPLY UNITS	Power supply expansion modules: 3A
WIRED KEYPADS	Elegant, Panda, LCD Keypad, RisControl Keypad
BUS SOUNDERS	ProSound, Lumin8
KEY READERS	Proximity Key Reader

## ID Number Formats

**Keypads, sirens, as well as expansion modules** (bus zone expanders, zone expanders, wireless expansion modules, utility output modules, power-supply expansion modules) that are connected via a RISCO bus line display on the keypad as per this example: **02(1:01) T=NZE08**

### EXPLANATION:

- **02** is the index number of keypad, siren, or voice/expansion module
- **1** is the RISCO bus line number that it is on
- **01** is the sequential, installer-set physical ID number
- **T** (type) is NZE08 (8-Zone Expander)

**System detectors and accessories** (other than keypads, sirens and expansion modules) have their zones display as per these examples:

- **Bus detector** connected via a bus zone expander: **4:B08:05**
- **Relay detector** wired to a zone expander: **4:E08:05**, or wired to a zone (1–8) on the terminal block: **4:E00:05**
- **Input zone** (relay detector wired directly onto a compatible type of bus device (such as the iWISE Bus and Elegant keypad), which thereby shares its bus line connection): **4:I08:05**
- **Wireless detector** connected to a wireless expansion module: **4:W08:05**

### EXPLANATION (for all 4 examples above):

- **4** is the RISCO bus line number
- The next value (for **B08**, **E08**, **I08**, or **W08**) is for the ID of the expansion module or input zone that the detector is connected to (**B** = bus zone expander, **W** = wireless zone expander, **I** = input zone, **E** = wired zone expander)
- **05** is the sequential, installer-set physical ID number

**NOTES: [For main panel terminal block wiring]:** For a bus zone expander wired to a bus line at the terminal block, its ID will show as B00. For a relay detector wired to a zone (1–8) at the terminal block, its ID will show as E00. For a UO module wired to a UO terminal at the terminal block, its ID will show as 0x (whereas x= zone number 1–6)

## Assigning ID Numbers (Setting DIP Switches) for Bus Devices

When installing each bus device, you must set its DIP switches to match its sequentially-assigned physical ID number **before the device is powered up**.

**NOTE:** If after power-up a device's DIP switch(s) are changed, it will be necessary to shut down the device's power and then power it up again.

➤ **To set a bus device's ID with its DIP switches:**

- For each bus device, set its physical ID number by placing its DIP switches to **ON** or **OFF** according to the table. Bus devices have between 3 and 5 DIP switches (check the device's packaged instructions for details, as some bus devices may have DIP switches that are not to be used for setting the device ID).

**NOTE:** Categories of bus devices with 3 DIP switches can be comprised of up to 8 IDs, those with 4 DIP switches up to 16 IDs, and those with 5 DIP switches up to 32 IDs. See the following examples and the table:

**EXAMPLE:** For a bus device with 3 DIP switches, to assign ID 02, DIP switch 1 needs to be set to ON, and DIP switches 2 and 3 need to be set to OFF.

**EXAMPLE:** For a bus device with 4 DIP switches, to assign ID 04, DIP switches 1 and 2 need to be set to ON, and switches 3 and 4 need to be OFF.

**EXAMPLE:** For a bus device with 5 DIP switches, to assign ID 07, DIP switch 1 needs to be set to OFF, DIP switches 2 and 3 need to be ON, and DIP switches 4 and 5 need to be OFF.

Bus device ID	DIP switches				
	1	2	3	4	5
01	OFF	OFF	OFF	OFF	OFF
02	ON	OFF	OFF	OFF	OFF
03	OFF	ON	OFF	OFF	OFF
04	ON	ON	OFF	OFF	OFF
05	OFF	OFF	ON	OFF	OFF
06	ON	OFF	ON	OFF	OFF
07	OFF	ON	ON	OFF	OFF
08	ON	ON	ON	OFF	OFF
09	OFF	OFF	OFF	ON	OFF
10	ON	OFF	OFF	ON	OFF
11	OFF	ON	OFF	ON	OFF
12	ON	ON	OFF	ON	OFF
13	OFF	OFF	ON	ON	OFF
14	ON	OFF	ON	ON	OFF
15	OFF	ON	ON	ON	OFF
16	ON	ON	ON	ON	OFF
17	OFF	OFF	OFF	OFF	ON
18	ON	OFF	OFF	OFF	ON
19	OFF	ON	OFF	OFF	ON
20	ON	ON	OFF	OFF	ON
21	OFF	OFF	ON	OFF	ON
22	ON	OFF	ON	OFF	ON
23	OFF	ON	ON	OFF	ON
24	ON	ON	ON	OFF	ON
25	OFF	OFF	OFF	ON	ON
26	ON	OFF	OFF	ON	ON
27	OFF	ON	OFF	ON	ON
28	ON	ON	OFF	ON	ON
29	OFF	OFF	ON	ON	ON
30	ON	OFF	ON	ON	ON
31	OFF	ON	ON	ON	ON
32	ON	ON	ON	ON	ON

## Installing Bus Devices

When installing bus devices, in addition to the guidelines presented in this manual, see their packaged installation instructions. For installing Power Supply Expansion modules, Utility Output Expansion modules, Wireless Expanders, Bus Sirens, and Zone Expanders, also see the *LightSYS Plus Installation and Programming Manual*.

### Installing Wired Keypads

Connect wired keypads to a bus line, or to a bus at the main panel terminal block. A wired keypad is the first device to be installed, as it is used to set defaults upon initial system power-up (language, time and date), to perform an Auto-Setting scan (for allocating bus-connected devices), and to configure parameters.

#### ➤ To install a wired keypad

1. Ensure the main panel is powered off.
2. Set the keypad's DIP switches (see *Describing Installer-Set ID Numbers for Bus Devices*, page 17) according to the instructions packaged with the keypad.
3. Set the keypad's back tamper switch (see keypad instructions).
4. Wire the keypad to a RISCO bus line, or to a bus on at the main panel terminal block (see *Main Panel Wiring Diagram*, page 10).
5. Refer to the keypad instructions for additional installation information.

### Connecting Individual Bus Detectors to a Bus at the Main Panel

#### ➤ To connect bus detectors individually on a bus at the main panel PCB:

1. Remove system power.
2. Connect each bus detector to the bus line per its packaged instructions.
3. Sequentially assign each bus detector's ID (01 – 32) and set it accordingly with its 5 DIP switches. See *Assigning ID Numbers (Setting DIP Switches) for Bus Devices*, page 19.

**NOTE:** For WatchOUT, LuNAR, WatchIN, BWare and Seismic set the switch that defines the detector's operational mode to **bus mode**.

4. Connect the 4 bus wires to their respective bus screw terminals on the main panel PCB (terminal block): AUX (RED), COM (BLK), BUS (YEL), BUS (GRN).

**NOTE:** For maximum operation stability, bus line wiring from any bus detector to the main panel should not exceed a total 300 meters (1000 feet).

**NOTE:** For testing the bus, see *Performing a Bus Test*, page 28.

## Connecting Multiple Bus Detectors using Bus Zone Expanders

Up to 4 RISCO Bus Lines

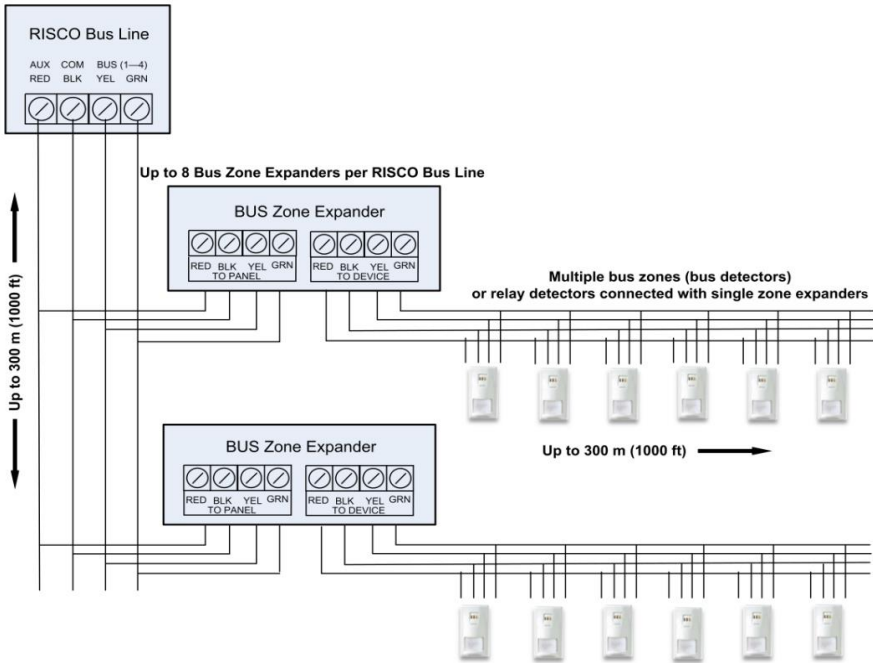

➤ **To connect multiple bus detectors to bus lines using bus zone expander(s):**

1. Remove system power.
2. At SW1 on the BZE (bus zone expander), use DIP switches 1—3 to sequentially set the BZE's physical ID number. Note that DIP switch 4 is not used.
3. At SW2 on the BZE set DIP switch 3 to **ON**.
4. At SW2 on the BZE, set DIP switch 4 to **OFF** to utilize the tamper switch, or set it to **ON** to disable the tamper.
5. Wire the bus line to the BZE terminals marked **TO PANEL**.
6. Set each bus detector's physical ID number sequentially, using each detector's DIP switches. **NOTE:** Do not assign the same physical ID number to more than one detector on the same BZE.
7. Wire each bus detector's terminals to the relevant BZE terminals marked **TO DEVICE**.

**NOTE:** For maximum operation stability, do not exceed 300 meters (1000 feet) of wiring from any BZE to the main panel and do not exceed 300 meters (1000 feet) of wiring from any BZE to the farthest detector it supports.

**NOTE:** For testing the bus, see *Performing a Bus Test*, page 28.

## Step 4: Connecting Relay Detectors

Wired non-bus detectors (“relay detectors”) can be connected to the system the following ways:

Refer the *LightSYS Plus Installation and Programming Manual* and the installation instructions for the relay detectors and for zone expanders.

- Connect relay detector(s) directly at the zone input terminals (Z1 – Z8) on the terminal block of the main panel PCB. See *Main Panel Wiring Diagram*, page 10.
- Connect multiple relay detectors onto 8-Zone Expanders.
- Connect relay detector(s) onto RISCO bus lines, each using a dedicated Single Zone Expander (see illustration, below).
- Connect a single relay detector directly onto bus devices which support an input zone. For the Elegant keypad, connect a relay detector to **ZONE IN** and **ZONE COM** terminals, and for the iWISE Bus detector connect to **Z1** and **COM** terminals.

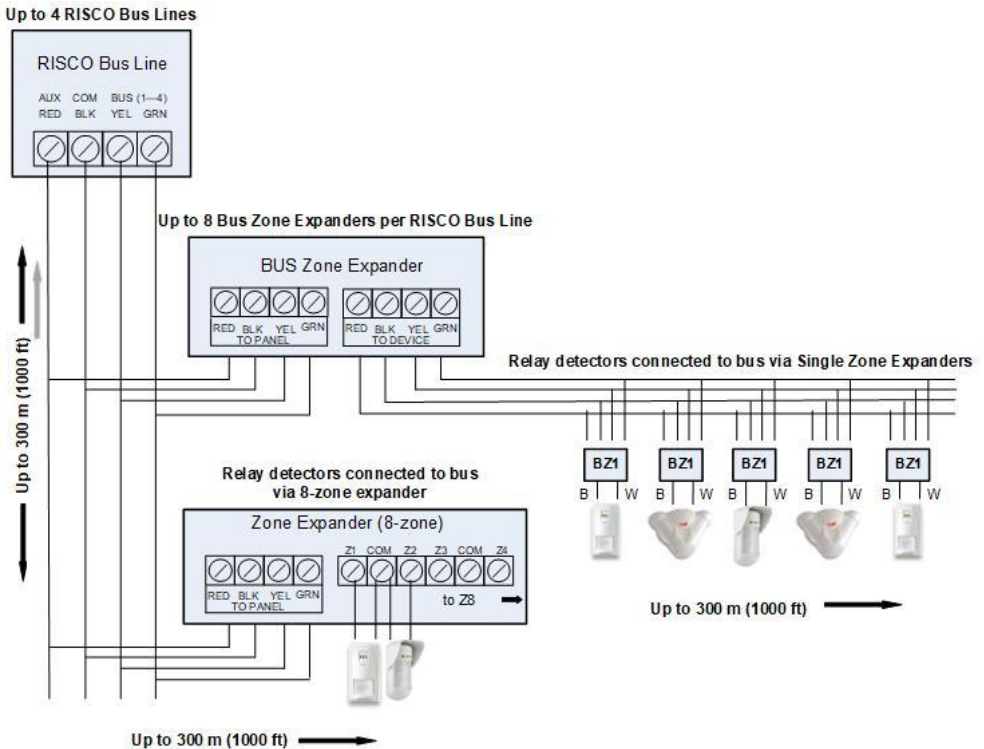

## Defining Zone Termination Resistance

End-of-line termination resistance can be defined for relay detectors, not wireless or bus detectors. Defining the end-of-line resistance involves first physically wiring resistors (if not already in place) at installation, and then afterwards selecting the zone's termination resistance option at the keypad during installer programming (see *Defining Zone Termination Resistance using the "Resistance" Option*, page 40).

**NOTE:** For relay detectors wired to zone expanders, during installer programming you separately define their individual termination resistance values, and also define it for the zone expanders.

## Wiring Resistors for Zone Termination Resistance

### > To wire termination resistors:

- For RISCO EOL (end-of-line) and DEOL (double-end-of-line) detectors without built-in termination resistance, install a 2.2K  $\Omega$  end-of-line resistor at the detector-side of each hard-wired zone
- For a detector with a tamper switch, you can use DEOL termination to save additional main panel connections
- For RISCO TEOL (triple-end-of-line) detectors without built-in end-of-line resistance, install 4.7K  $\Omega$ , 6.8K  $\Omega$  and 12K  $\Omega$  resistors at the detector-side of each hard-wired zone. TEOL is supported to identify detector masking and trouble.

## Zone Termination Configuration Options

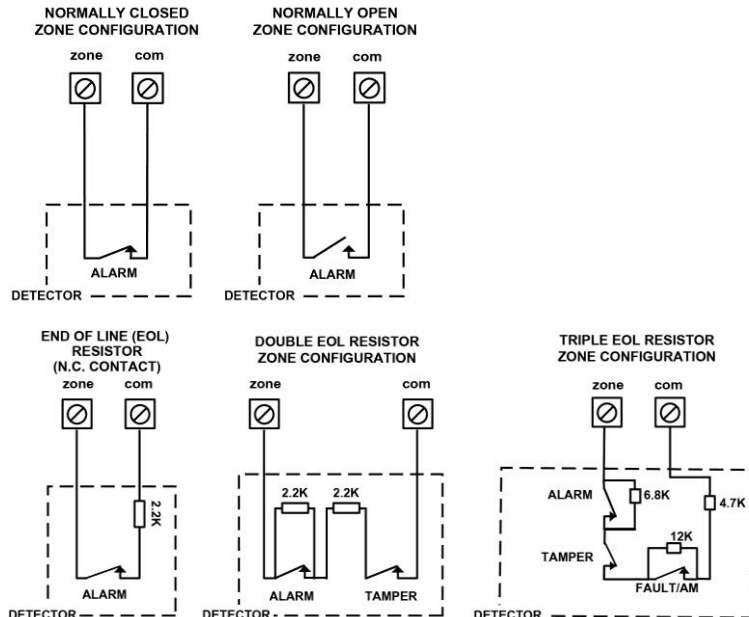

## Step 5: Connecting the Backup Battery and Mounting the Main Panel

### Connecting the Backup Battery

The main panel backup battery is not supplied with the system. Inside the main panel box/enclosure, install a **rechargeable battery, up to 21 Ah, 12 V**.

#### WARNINGS:

- To avoid damaging system components, do not connect the backup battery until all installation tasks are completed, and the system is ready for initial power-up.
- The backup battery must be replaced about every 3—5 years.
- There is a risk of explosion if a battery is replaced with an incorrect type.
- Dispose of used batteries per applicable law and regulation.
- Battery charging takes at least 24 hours before it can be fully used for backup

#### ➤ **To connect the main panel's backup battery:**

Connect the leads of the battery cable to the respective (+) and (–) terminals on the backup battery with correct polarity. Then insert the battery in place in the main panel housing (see box/enclosure instructions) and attach the cable to the battery connector on the panel PCB (*Main Panel Wiring Diagram*, page 10).

### Mounting the Main Panel

#### ➤ **To mount the main panel:**

1. Close up the box/enclosure and then mount it to the wall. See instructions packaged with the box/enclosure, the *LightSYS Plus Installation and Programming Manual*, as well as *Step 1: Creating a Plan for Mounting the System*, page 8.
2. You are now ready for powering-up the system and system initialization tasks.



# System Initialization, Device Allocation, General System Configuration

For installer programming using the Configuration Software, see its documentation.

## Step 1: Working with the Keypad and Installer Menus









### Describing Dynamic Keypad Menus

The LightSYS Plus installer menus and user menu are dynamic, in that they display menu items according to the devices connected in the system.

#### Table of Menu Navigational Keys



The following describes the typical Elegant keypad keys used for programming:

**NOTE:** Other keypad buttons may differ – see their packaged instructions.

Key	Description
1–0	For entering codes, using quick keys (to quickly access a menu option, labels, and for entering other numeric values.
	To go back a step in the menu, to exit a menu or return to the beginning of a menu.
	Long-press to get system status
	Confirm (after entering) / OK / Save
   	For scrolling through menus and menu options, and for toggling, such as between “ON” and “OFF” options.
 	To toggle between options
A, B, C, D	Used to select a group

### Designating Labels

The following table describes all the available characters at the Elegant keypad.

Key	Character Options	Key	Character Options
1	1 . , ' ? ! \ " - < > @ / : _ + * #	7	7 P Q R S
2	2 A B C	8	8 T U V
3	3 D E F	9	9 W X Y Z
4	4 G H I	0	0 (also use for blank space)
5	5 J K L	A	To toggle between lower case and capital letter
6	6 M N O		To scroll through all possible characters,
			to toggle through options (Yes/No)

## Entering the Installer Programming Menu at Initial System Setup

After initial system power-up, language, time and date setting, viewing enabled zones and defining system partitions, you'll be in the installer Programming menu, at Auto Settings.

**IMPORTANT:** After you finish initial system setup programming tasks from the installer Programming menu, in order to exit you must perform the procedure for *Step 2: Exiting Installer Programming Menu after Initial System Configuration*, page 49.

## Step 2: Powering-Up and Initializing the System

When a new system is powered-up the first time, here are the initialization steps:

- 1: Initial power-up & language selection. The system automatically connects to the Cloud.
- 2: View enabled zones, define the maximum number of system partitions, and set the time & date.

### Initial System Power-Up and Language Selection

**NOTE:** During regular system operation (after initial system setup) the language can be subsequently changed by pressing  + 9 simultaneously.

#### ➤ To initially power-up and select a language:

1. Power-up the main panel; the keypad panel takes a few seconds to initialize (there may be an automatic 3-minute upgrade that runs automatically, during which the upgrade and power icons may display on the keypad – **make sure you do not disconnect**).
2. Press  when prompted.
3. Scroll to select a language, and then press **OK** (✓).

### Defining Partitions after Initialization

#### ➤ To define the partition quantity after system initialization:

1. Go to: 1 > 5 > 8 (**System > Settings > Partition Qty**, and then press ✓; **MAXIMUM PARTITIONS? 08 (08–32)** displays.
2. Enter the maximum number of partitions to enable in the system – the default is 08 (meaning up to 8), but up to 32 can be selected. If you want more than 8 partitions, enter the number. Now press ✓.

**NOTE:** You can opt to define the maximum partitions at a later stage – from the

keypad (during installer programming), or from the Configuration Software.

## Step 3: Allocating and Configuring Installed Components

Allocate and configure all installed communication/expansion modules and bus devices via Auto Setting.

### Auto-Setting Allocation of Communication Modules and Bus Devices

Performing an Auto-Setting scan finds all installed communication modules and bus devices connected in the system. As you view the results, you allocate (“enable”) each, and then you can configure their settings – either now, or later during installer programming (for configuration details see *Manually Allocating & Configuring Communication Modules*, page 29, and *Manually Allocating & Configuring other Modules and Bus Devices*, page 31).

➤ **To perform an Auto-Setting system scan:**

1. Upon accessing the installer Programming mode after system initialization, when **BUS Device: 1)Automatic** displays (Auto Settings feature), press **OK** (✓); **BUS SCANNING** displays during scanning, until the results display - the communication modules first, followed by the other bus devices that are found. For a description of the results, see *Describing Auto-Setting Results*, page 28.
2. Press ✓ to enable the first communication module displayed, and keep pressing ✓ to progress through its parameter configuration screens (which you can configure now, or later during installer programming).
3. Press ✓ again to advance to the next communication module (if applicable) – followed by all other bus devices found, and again enable/configure for each.
4. Make sure all the communication modules/bus devices found in the scan match all the communication modules/bus devices physically connected in the system. When **BUS Device: 1)Automatic** displays again and the panel beeps, it indicates you have finished the Auto-Setting scan.
5. Now you can perform a Bus Test to ensure good communication between the allocated bus devices and the main panel (see *Performing a Bus Test*, page 28).

**NOTE:** If you subsequently add more bus devices, you can either allocate and configure them manually, or repeat an Auto-Setting scan at:

**installer Programming menu > 7)Install > 1)BUS Device > BUS Device: 1)Automatic**

## Describing Auto-Setting Results

At the keypad, the results of an Auto-Setting scan first show the connected communication modules. The next results displayed are for connected keypads, expansion/voice modules and bus detectors. Results display as per this example: **(3:02:01) T=LCD**

### EXPLANATION:

**NOTE:** Dashes (—) appear instead of digits when a parameter is not relevant, for example, for communication modules (since they are “on-board” on the PCB, and not on a bus line).

- 3 is the bus line it is connected to
- 02 is the expander ID
- 01 is its sequential, installer-set physical ID number for bus devices (see *Describing Installer-Set ID Numbers for Bus Devices*, page 17). Note that communication modules will always appear as 01.
- T is the type, which, in this example is **LCD keypad**

## Performing a Bus Test

A Bus Test checks each installed bus device and communication module to ensure adequate connectivity quality.

A result of 97% or less than may mean that there are bus connection problems.

### ➤ To perform a Bus Test:

1. From the **installer Programming menu**, go to: **7 > 1 > 3 > 1 (Install > Bus Device > Testing > Bus Test)**; BUS TEST displays for a few seconds until the BUS COM QUALITY results display.
2. Scroll to view the results for each bus device/module on the tested bus. If a result is not adequate, check physical connections and DIP switch positions, and then repeat the test. Results display as per this example: **GSM :001 =100%**

### EXPLANATION:

- **GSM** is the communication module/bus device description
- **001** is the communication module/bus device index number
- **100%** is the result

## Manually Allocating & Configuring Communication Modules

If you didn't yet run an Auto-Setting scan to allocate ("enable") each installed communication module, from the installer Programming menu, you can do so manually, as well as configure its relevant parameters.

**IMPORTANT:** If an allocated communication module is no longer to be utilized, you must disable it (cancel its allocation) via this manual process. After cancelling, if needed, you can then re-write over it to newly allocate another communication module.

**NOTE:** After manually programming communication modules, you can perform a Bus Test (see *Performing a Bus Test*, page 28).

### GSM Modules

1. From the **installer Programming menu** select 7> 1> 2, scroll to 10) GSM, and then press **OK** (✓).
2. Press  to toggle to the type of GSM module installed (or select **NONE** to cancel its allocation), and then press ✓.

### Entering or Deleting a SIM Card PIN

If your SIM card requires a PIN (personal ID number) you will need to enter it. If not, you will need to disable it.

#### ➤ To enter or delete a SIM card PIN:

1. From the **installer Programming menu** select 5 > 1 > 2 > 5 > 1, enter the PIN, and then press **OK** (✓).

-OR-

If a PIN is not needed, you can choose to disable it by inserting the SIM card in a cell phone and disabling the code.

2. You can manually define APN definitions if you don't have them configured automatically (the default). See *Defining APN Automatically and Manually*, page 30.

**NOTE:** It is recommended to test the operation of a SIM card by conducting a call and testing the GSM signal strength. See *Testing the System*, page 50.

## Defining APN Automatically and Manually

After the SIM card is installed and upon establishing GSM/GPRS communication, the system's auto-APN feature will automatically configure the APN definitions. However, there may be cases where you will need to manually define the APN by entering the APN (Access Point Name) code supplied from the cellular provider, user name, and password.

**NOTE:** If any of the APN definition fields are populated manually, the auto-APN feature will not operate.

### ➤ To manually set the APN definitions:

1. From the installer Programming menu, select: **5 > 1 > 2 > 2 > 1** (**Communication > Method > GSM > GPRS > APN code**), then press **OK (✓)**.
2. Enter the **APN code**, and then press **✓**.
3. Scroll to **2) APN User Name**, press **✓**, enter the **user name**, and press **✓**.
4. Scroll to **3) APN Password**, press **✓**, enter the **password**, and press **✓**.

## IP/Wi-Fi Modules

1. From the **installer Programming menu** select **7> 1> 2**, scroll to **11) IP**, and then press **OK (✓)**.
2. Press  to toggle to the type of IP module installed (or select **NONE** to cancel its allocation), and then press **✓**.

### Setting Dynamic IP / Static IP

Go to: **5 > 1 > 3 > 1 > 1**, scroll to either **1) Dynamic IP** or **2) Static IP**, then press **✓**.

## Long-Range Radio Transmitter Module

See the *LightSYS Plus Installation and Programming Manual* and the LRT module's instructions.

1. From the **installer Programming menu** select **7> 1> 2**, scroll to **14) LRT**, and then press **OK (✓)**.
2. Press  to toggle to the type of LRT module installed (or select **NONE** to cancel its allocation), and then press **✓**.

## Cellular On Bus (COB)

See the COB instructions.

1. From the **installer Programming menu** select **7→1→ 2**, scroll to **13) COB**, and then press **OK (✓)**.
2. Toggle to the type of COB module installed (or select **NONE** to cancel its allocation), and then press **OK**.



## Manually Allocating & Configuring other Modules and Bus Devices

If you didn't yet run an Auto-Setting scan to allocate (enable) all the installed non-communication modules (for example, expansion modules) or other bus devices – or if you are adding new ones and don't want to perform an Auto-Setting scan of the entire system, instead you can allocate them manually. Also, if you didn't configure parameters during the Auto-Setting scan, you can do so now.

**IMPORTANT:** If no longer utilizing a previously allocated module/bus device, you'll need to manually cancel its allocation. After cancelling, if needed, you can then re-write over it (to newly allocate) another module/bus device.

**NOTE:** After manually programming other modules and bus devices, you can perform a Bus Test to ensure good communication between the bus devices and the main panel (see *Performing a Bus Test*, page 28).

### Wired Keypads

1. From the **installer Programming menu**, select **7> 1> 2**, then scroll to **01)Keypad** and press **OK** (✓).
2. Scroll to, and then edit the keypad's physical ID number to match its DIP switch settings (see *Describing Installer-Set ID Numbers for Bus Devices*, page 17).
3. Press  to toggle to the correct keypad type (or select **NONE** to cancel its allocation), and then press ✓; Assign to Partition displays.
4. Scroll to manually edit (type in) the partition number or press  to toggle to the correct partition number, and then press ✓; the Mask screen displays where you enable operability of specific partition(s) with this keypad. By default, for keypad 01 all partitions are enabled.
5. While scrolling through each block of partitions, designate the partition(s) to allow operation via the keypad. Enter a partition number to select it (it will display), or enter the number again to clear it (it will not display). Then press ✓; Controls / 1) Emergency displays.
6. Scroll to Control parameters and press  to enable/disable (Y/N) as needed:
  - **1)Emergency** – to operate the emergency quick keys at the keypad.
  - **2)Multi View** – to view from this keypad the status of all masked partitions (select **Y**) or only the partitions (select **N**).
  - **3) Exit beeps** – (for a 2-Way wireless Slim keypad with bypass)— sounds beeps during the exit time in stay arming.
  - **4)Supervision** – to enable (Y) or disable (N) supervision for a wireless keypad.
7. Press ✓ to go to the next keypad, and repeat this procedure from step 2.



## Zone Expanders

1. From the **installer Programming menu**, select **7> 1> 2**, scroll to **02) Zone Expand.**, and then press **OK (✓)**.
2. Scroll to, and then edit the zone expander's physical ID number to match its DIP switch settings (*Describing Installer-Set ID Numbers for Bus Devices*, page 17).
3. Press  to toggle to the type (**NZE08** for an 8-zone expander), or select **NONE** to cancel its allocation, then press **✓**.
4. Select the zone termination resistance if applicable by scrolling to the correct resistor values (in ohms), then press **✓** to advance to the next zone expander.
5. Repeat from step 2 for all additional zone expanders.

## Utility Output Modules



1. From the **installer Programming menu**, select **7> 1> 2**, scroll to **03) Util. Output**, and then press **OK (✓)**.
2. Scroll to, and then edit the module's physical ID number to match its DIP switch settings (see *Describing Installer-Set ID Numbers for Bus Devices*, page 17).
3. Press  to toggle to the UO type (or select **NONE** to cancel its allocation), and then press **✓**.

## Power Supply Modules

1. From the **installer Programming menu**, select **7> 1> 2**, scroll to **04)Power Supply**, and then press **OK (✓)**.
2. Scroll to, and then edit the PS module's physical ID number to match its DIP switch settings (see *Describing Installer-Set ID Numbers for Bus Devices*, page 17).
3. Press  to toggle to the PS type (or select **NONE** to cancel its allocation), and then press **✓**.
4. Select the partition number(s) for the power supply module. While scrolling through each block of partitions, designate the partition(s) to allow operation via the keypad. Enter a partition number to select it (it will display), or enter the number again to clear it (it will not display).
5. Press **✓**; **1)BELL/L.SPEAK N** displays
6. Press  to toggle between **Y** (yes) or **N** (no) for enabling or disabling the bell / loudspeaker, and then press **✓**.
7. Repeat from step 2 for all additional power supply modules.



## Wireless Expanders

1. From the **installer Programming menu**, select **7> 1> 2**, scroll to **05)WL Expander**, and then press **OK (✓)**.
2. Scroll to, and then edit the WL expander's physical ID number to match its DIP switch settings (see *Describing Installer-Set ID Numbers for Bus Devices*, page 17).
3. Press  to toggle to **WM** (wireless module), or select **NONE** to cancel its allocation, and then press **✓**.
4. Press  to toggle to **Y** or **N** for the bypassing box tamper, then press **✓**.

## Wireless Video Expanders

1. From the **installer Programming menu**, select **7→ 1→ 2**, scroll to **05)WL Expander**, and then press **OK (✓)**.
2. Scroll to, and then edit the WL expander's physical ID number to match its DIP switch settings (see *Error! Reference source not found., page Error! Bookmark not defined.*).
3. Toggle to **WVE** (wireless video expander), or select **NONE** to cancel its allocation, and then press **OK**.
4. Toggle to **Y** or **N** for bypassing the box tamper, then press **OK**.

## Wireless Security Modules

1. From the **installer Programming menu**, select **7→ 1→ 2**, scroll to **05)WL Expander**, and then press **OK (✓)**.
2. Scroll to, and then edit the WL expander's physical ID number to match its DIP switch settings (see *Error! Reference source not found., page Error! Bookmark not defined.*).
3. Toggle to **WSM** (wireless security module), or select **NONE** to cancel its allocation, and then press **OK**.
4. Toggle to **Y** or **N** for bypassing the box tamper, then press **OK**.

## Proximity Key Readers

1. From the **installer Programming menu**, select **7> 1> 2**, scroll to **06)Prox Key Rd**, and then press **OK (✓)**.
2. Scroll to, and then edit the PRK's physical ID number to match its DIP switch settings (see *Describing Installer-Set ID Numbers for Bus Devices*, page 17).
3. Press  to toggle to **PRK** (Proximity Key Reader) or select **NONE** to cancel its allocation, and then press **✓**; the Mask screen displays where you can enable



- operability of specific partition(s) when using this PKR.
4. While scrolling through each block of partitions, designate the partition(s) to allow operation via the PKR. Enter a partition number to select it (it will display), or enter the number again to clear it (will not display), then press ✓.
  5. Scroll through the various “Controls” options and toggle between **Y** and **N** for each using , and then press ✓.
  6. Repeat this procedure from step 2 for all additional PKRs.

## Voice Module

The LightSYS Plus supports 1 voice module.

1. From the **installer Programming menu**, select **7> 1> 2**, scroll to **07)Voice Module**, and then press **OK** (✓).
2. Press  to toggle to **T=Voice** (the Voice Module), or select **NONE** to cancel its allocation), and then press ✓.
3. Enter the 2-digit **R. Phone Code** (remote phone code), and then press ✓.
4. Scroll to select a language for voice announcements, and then press ✓.

## Sounders (Sirens)

1. From the **installer Programming menu**, select **7> 1> 2**, scroll to **08)Sounder**, and then press **OK** (✓).
2. Scroll to, and then edit the sounder’s physical ID number to match its DIP switch settings (see *Describing Installer-Set ID Numbers for Bus Devices*, page 17).
3. Press  to toggle to the type (or select **NONE** to cancel its allocation), and then press ✓.
4. Select the partition number(s) for the sounder. While scrolling through each block of partitions, designate the partition(s) to allow operation via the keypad. Enter a partition number to select it (it will display), or enter the number again to clear it (it will not display).
5. Scroll to and select the partition number for the siren, and then press ✓.
6. Select **Y** to enable the sound (or use  to toggle to **N**), and then press ✓.
7. Select **Y** or **N** for squawk sound, and then press ✓.
8. Select **Y** or **N** for squawk strobe, and then press ✓.
9. Repeat from step 2 for all additional sirens.

## Bus Zones (Bus Detectors)

1. From the **installer Programming menu**, go to: 7>1>2>0>9 (**Install > Bus Device > Manual**, and scroll to **09)Bus Zone**) and then press **OK (✓)**; the first available (non-allocated) bus zone displays as per this example. Note that the empty fields in the parenthesis indicate that the zone has not yet been allocated:



```
Select (-:-- -- :- -)
017) ZONE 017
```

2. Scroll to the zone that you want to allocate the bus zone to, then press **OK (✓)**; the following (example) displays:

```
BUS ZONE: (017)
(1:00:01) T=xxxx
```

### EXPLANATION:

- **1** is the bus line number
- **00** is the bus zone expander ID (1—32) that the bus detector is connected to (00 means wired to a bus line at the main panel PCB)
- **01** is the installer-set physical ID number for the bus detector
- **T** is the type (description).

3. Scroll to and then edit the bus detector’s physical ID number to match its DIP switch settings (see *Describing Installer-Set ID Numbers for Bus Devices*, page 17).
4. Press  to toggle to the correct bus zone type (or select **NONE** to cancel its allocation), and then press **✓**; “Link Bus Input to Zone ####?” displays (whereas ### is the zone number).
5. To link (enable), use  to toggle to **Y**, and then press **✓**.
6. Repeat this procedure for all additional bus detectors.

## Bus Zone Expanders

1. From **installer Programming menu**, go to: 7>1>2>13 (**Install > Bus Device > Manual > Bus Expander**); the first BZE (Bus Zone Expander) displays. See *Describing Installer-Set ID Numbers for Bus Devices*, page 17 for a description of the displayed BZE format.
2. Scroll to, and then edit the BZE’s physical ID number to match its DIP switch settings (see *Describing Installer-Set ID Numbers for Bus Devices*, page 17).
3. Press  to toggle to the type (or select **NONE** to cancel its allocation), then press **OK (✓)**.
4. Repeat from step 2 for all additional BZEs.



## Step 4: Allocating Wireless Zones

Multiple 1-way and 2-way wireless detectors and accessories are connected to the system via wireless expansion modules – each of which supports multiple wireless zones and is connected to a RISCO bus line or at the main panel PCB.

### Allocating Wireless Expanders

Wireless expanders must be allocated before their respective detectors/accessories.

➤ **To allocate wireless expanders:**

1. From the **installer Programming menu**, go to 7 > 1 > 2 > 0 > 5 (**Install > Bus Device > Manual > WL Expander**).
2. Scroll to, and then edit the WL expander’s physical ID number to match its DIP switch settings (see *Describing Installer-Set ID Numbers for Bus Devices*, page 17).
3. Press  to toggle between **WM** (to enable the Wireless Expander module) or select **NONE** (to cancel its allocation), and then press **OK** (✓).
4. Define whether to bypass the wireless expander box tamper, using  to toggle between **Y** (to bypass) and **N**, and then press ✓.

### Allocating Wireless Devices

Each wireless transmitting device must be allocated (via keypad or Configuration Software) by either sending an RF transmission (see below), or by entering the device’s 11-digit code (see the *LightSYS Plus Installation and Programming Manual*).





➤ **To allocate wireless devices via RF transmission (from Elegant keypad):**



1. From the **installer Programming menu**, go to 7 > 2 > 2 > 1 > 1 (**Install > WL Device > Allocation > By RF > Zone**).
2. If you have multiple wireless receivers, scroll to the first one for which you want to allocate it’s wireless devices, and then press **OK** (✓); Each zone appears in one of the following formats: “**Select** (—:— —:— —)” which indicates the zone is available for allocating, or “**Select** (3:E02:06)” which, in this example, indicates the zone has already been allocated.

**NOTE:** If you try to allocate the same wireless zone number twice, the second allocation will re-write (cancel) the prior allocation.

3. Scroll to the zone number you want to allocate (or enter the zone number using 3 digits – for example enter 022 for zone 22), and then press ✓; the wireless expander is now in “learn” mode for the next 180 seconds.
4. Per the table below, within the remaining time, send an RF transmission from a wireless device that you want to sync with the selected wireless expander. If “*write message not found*” displays, it means the transmission was not received and the device didn’t get allocated.

## Sending Wireless Device RF Transmissions

Wireless devices (1-way / 2-way)	To send an RF transmission:
<b>Detectors :</b> <ul style="list-style-type: none"> <li>• WatchOUT</li> <li>• BWare</li> <li>• WL Beyond DT</li> <li>• WL Indoor/Outdoor Curtain</li> <li>• iWave</li> <li>• iWise</li> <li>• Door-Window Contacts (Dual Channel, Pulse Count, Universal)</li> <li>• Shock</li> <li>• Glassbreak</li> <li>• PIR CAM</li> <li>• Slim Contact</li> </ul>	Insert battery. Press and hold the tamper switch for at least 3 seconds.
<b>Smoke &amp; heat detectors</b>	Insert battery. Transmission is sent automatically within 10 seconds.
<b>Gas detectors</b>	Insert battery. Within 10 seconds, press and hold the test button for 3 seconds.
<b>CO detectors</b>	Insert battery. Within 10 seconds, press and hold the test button for 3 seconds.
<b>Flood detectors</b>	Insert battery. Press both tamper buttons (back and cover) for at least 3 seconds.
<b>WL beams</b>	Insert battery. Press tamper spring for 5 seconds. Observe DIP switch settings according to model and tamper usage.
<b>Sirens (Round Indoor siren, Lumin8 siren, Outside sirens)</b>	Insert battery. Within 10 seconds, press and hold the tamper switch for 3 seconds.
<b>2-way, 8-button remote control</b>	Press both buttons (  and  ) for at least 7 seconds.
<b>4-button Panda Keyfob</b>	Press both keys (  and  ) for at least 2 seconds
<b>4-button rolling code keyfob</b>	Press and hold  for at least 5 seconds (the LED lights up twice during the 5 seconds - the second time indicates the transmission is being sent).
<b>2-button panic keyfob</b>	Press both buttons for at least 7 seconds.

<b>Wireless devices (1-way / 2-way)</b>	<b>To send an RF transmission:</b>
<b>Wristband panic transmitter</b>	Press both buttons for at least 7 seconds. The red LED lights up upon transmission.
<b>2-Way WL Slim Keypad</b>	Press and hold both buttons (  and  ) for at least 2 seconds.

5. Repeat from step 3 for each additional wireless transmitting device to be allocated for this wireless expander.
6. After you have allocated the devices for this specific wireless expander, repeat the procedure from step 2 for all additional wireless expanders (and then their respective transmitting devices).
7. Now define the basic parameters for the wireless zones, such as labels, partitions, etc. (see *Step 5: Basic Zone Configuration for All Zone Types*, below).
8. After, it may be beneficial to perform advanced programming such as measuring and setting the background noise threshold level, followed by performing a wireless communication test (see *Advanced Programming for Wireless Zones*, page 42).

## Step 5: Basic Zone Configuration for All Zone Types

### Defining Basic Parameters

You can define basic parameters for all types of zones. The relevant parameters display dynamically according to the respective zone type.

You can define all the various zone parameters for one zone at a time by using the **“One By One”** option, or you can take a specific parameter and define it accordingly for multiple zones by using the **“By Category”** option. Also you may need to define the zone’s termination resistance (**“Resistance”** option) if using relay detectors and zone expanders.

After defining the basic zone parameters, you can define advanced parameters for bus zones and wireless zones (see *Step 6: Advanced Zone Configuration for Bus Zones and Wireless Zones*, page 41).

### Describing Zone Information Displayed at the Keypad

At the keypad you will be entering the zone information which will be displayed as per this example: **Z=125 (1:E03:06):**

**EXPLANATION:**

- **Z=125** is the zone’s index number (up to 512 zones possible)
- **1** is the RISCO bus line number (1–4)
- **E03** is the expansion module ID (it will show as E00 if wired at the terminal block)
- **06** is the zone’s installer-set physical (and sequential) ID number

## Defining Zone Parameters using the “One-By-One” Option

This option lets you to define all zone parameters, for one zone at a time.

### ➤ To define zone parameters using the One-By-One option:

1. From the **installer Programming menu** go to: **2 > 1 > 1 (Zones > Parameters > One by One)**; a zone number (i.e. Z=001) displays in the format described above.
2. Using the scroll keys, enter another 3-digit zone number (for the next zone that you want to define its parameters), then press **OK (✓)**. If (–:– – –:– –) displays, it means the zone hasn’t been allocated (parameters can’t be defined).
3. You can now define the following parameters for this specific zone (moving from one parameter type to another by pressing ✓):
  - a. **[Labels]:** You can give the zone a descriptive “label” by typing over the default “ZONE” (see *Designating Labels*, page 25), and then press ✓.
  - b. **[Partitions]:** To select partitions (up to 32) to associate with the zone, scroll to the partitions, which are grouped in blocks: the first block contains partitions 01–08 (the default) if that is what was enabled. If additional partitions were enabled, scroll to all the blocks (of ten) they are located in: block 01–10, 11–20, 21–30, and 31–32. In each block, enter the relevant partition number/s (each will display as P=#) and then before pressing ✓, scroll to the next blocks and do the same. When finished, press ✓.
  - c. **[Group]:** For applicable group/s (a specific area that can be armed within a specific partition – up to 4 groups [A–D] maximum per each partition). For each group letter, toggle with  between **Y** (select) and un-select, then scroll to the next group letter, if needed. When finished press ✓.
  - d. **[Zone Type]:** Scroll to select the zone type (35 zone types – see the *LightSYS Plus Installation Manual* for descriptions) and then press ✓.
  - e. **{Arm Sound}:** Scroll to select an arming sound, and then press ✓. Options: **silent, bell only, buzzer only, bell+buzzer, door chime.**
  - f. **[Stay (Partial Arm) Sound]:** Scroll to select a partial arming sound, then press ✓. Options: **silent, bell only, buzzer only, bell+buzzer, door chime.**

- g. **[Disarm Sound]:** Scroll to select the disarming arm sound for this zone, and then press ✓. Options: **silent, door chime.**
  - h. **[Terminate]:** For wired relay-detector zones only. Scroll to select the zone termination type, then press ✓. Options: **NC, EOL, DEOL, N/O, TEOL.**
  - i. **[Response]:** Scroll to select zone response time, then press ✓. Options: **NORMAL (400 ms), LONG (1 sec.), FAST (10 ms), and E. FAST (1 ms).**
4. Press ✓ to go to the next zone, and repeat the procedure for all other zones.

## Defining Zone Parameters using the “By Category” Option

For a specific parameter type, this lets you to define it accordingly for multiple zones (as you go from one to another, scrolling through all zones in the system).

### ➤ To define zone parameters using the By-Category option:

1. From the **installer Programming menu** go to: **2 > 1 > 2 (Zones > Parameters > By Category).**
2. Scroll to arrive to the parameters and their respective options to modify. Parameters: **Label, Partition, Type, Sound, Termination, Loop Response, Advanced.** Then press **OK (✓)** to confirm after each selection. Use the numeric keys to enter the zone number (or numeric values) where needed.

## Defining Zone Termination Resistance using the “Resistance” Option

Regardless of which method was used to define zone parameters (One-by-One, or By Category), if you had specified end-of-line termination in the Termination parameter (for wired zones only), you have only specified what **type** of termination configuration to apply for the wired zone – EOL, DEOL, TEOL, NC, or NO. In the Resistance option, you now define the **termination resistance value(s)** for the wired zone.

If using a zone expander (8-zone, single-zone), during installer programming, in addition to defining the termination resistance for all the relay detectors connected to it – which can be any combination of EOL, DEOL, TEOL detectors, you also need to define the termination resistance compatibility for the zone expander itself, according to the “highest” level of any relay detector you intend to connect to it. For example, if you have EOL, DEOL and TEOL detectors connected to a zone expander (or if you have only EOL and DEOL detectors, but want to leave open the possibility of adding a TEOL detector to the zone expander in the future), you will need to set the zone expander’s termination resistance values to TEOL – the “highest” level.



Default termination resistance values for RISCO relay detectors are:

- **EOL (end-of-line):** 2.2K  $\Omega$
- **DEOL (double end-of-line):** 2.2K  $\Omega$ , 2.2K  $\Omega$
- **TEOL (triple end-of-line):** 4.7K  $\Omega$ , 6.8K  $\Omega$ , 12K  $\Omega$

**NOTE:** For retrofit installations, you can define the resistance compatibility according to the resistors already installed in the relay detectors.

➤ **To define zone termination resistance values:**

1. At the installer **Programming menu**, go to: **2 > 1 > 3 (Zones > Parameters > Resistance)**.
2. Scroll to the detector-compatible termination resistance option, and then press **OK (✓)**:

**Zone Termination Resistance Values (in Ohms)**

	EOL	DEOL	TEOL		EOL	DEOL		EOL	DEOL
00	Custom			05	3.74K	3.74K, 6.98K	10	3.3K	3.3K, 3.3K
01	2.2K (default)	2.2K, 2.2K (default)		06	2.7K	2.7K, 2.7K	11	5.6K	5.6K, 5.6K
02	4.7K	4.7K, 6.8K	4.7K, 6.8K, 12K (default)	07	4.7K	4.7K, 4.7K	12	2.2K	2.2K, 1.1K
03	6.8K	6.8K, 2.2K		08	3.3K	3.3K, 4.7K	13	2.2K	2.2K, 4.7K
04	10K	10K, 10K		09	1K	1K, 1K			

## Step 6: Advanced Zone Configuration for Bus Zones and Wireless Zones

### Advanced Programming for Bus Zones

➤ **Configuring advanced parameters for bus zones:**

1. At the installer **Programming menu**, go to: **2>1>2>7>4 (Zones > Parameters > By Category > Advanced > BZ Parameters)**, and then press **OK (✓)**.
2. Scroll to the bus zone number to program, and then press **✓**.
3. Scroll through the options and configure the relevant parameters for the zone, pressing **✓** after each to confirm.

## Advanced Programming for Wireless Zones

### ➤ Configuring advanced parameters for wireless zones:

1. At the **installer Programming menu**, go to: 2>1>2>7>5 (**Zones > Parameters > By Category > Advanced > WL Parameters**), and then press **OK (✓)**.
2. Enter the wireless zone number to program, and then press **✓**.
3. Scroll through and configure the relevant parameters for the zone, pressing **✓** after each to confirm.

### Measuring Background Noise Level and Defining its Threshold Limit

If the system uses wireless devices, you can measure (“calibrate”) the background noise that the main panel detects, and also define the acceptable threshold value. Background noise (RF interference) is typically generated by other non-system devices operating in close proximity to the system, and high amounts may interfere with the system, causing “jamming.” Communication between your system’s wireless devices (via wireless expander module/s) and the main panel must be stronger than any detected background noise at the main panel, therefore regardless if the current level of background noise the panel detects seems insignificant, it is recommended to additionally perform a Wireless Communication Test, to check a wireless device’s signal (see *Performing a Wireless Comm. Test for Measuring Signal Strength*, page 43).

Measuring the background noise level provides an indication whether the main panel is mounted at a good location, and defining the threshold limit value enables you to determine how much background noise your system will tolerate before it generates jamming events. The lower you define the threshold value, the more sensitive the system will be (it will report jamming events more frequently), and the higher you define the threshold value, the less sensitive the system will be (it will report jamming events less frequently).

### ➤ To calibrate (measure) the background noise:

1. From the **installer Programming menu**, select 7 > 2 > 1 (**Install >WL Device > RX Calibration**); **CHOOSE RECEIVER** (wireless expander) displays.
2. Scroll to select the wireless expander module, and then press **OK (✓)**; the most recently measured result (“**THOLD**”) for that wireless expander module displays.
3. To re-calibrate (re-measure) the background noise, press  to toggle to **Y** (yes), and then press **✓**; the new result (“**NEW THOLD**”) displays.

4. Press ✓ to confirm. If the resulting value is not acceptable, for example if it is high due to what you believe is a source of high background noise that's inherent to the main panel's location, then you may want to move the main panel to a better location. Another option you may consider is to re-define the noise level threshold value (see below) – for example, so the system will be more “forgiving” and generate less jamming events.

➤ **To define the noise level threshold value:**

1. From the **installer Programming menu**, select **7 > 2 > 1 (Install >WL Device > RX Calibration)**; CHOOSE RECEIVER (wireless expander) displays.
2. Scroll to select the wireless expander module, and then press **OK (✓)**; the most recently measured result (“THOLD”) for that Wireless Expander module displays.
3. Press  to toggle to **N (no)**, and then press ✓; the most recently measured result displays again, over which you can now enter a new threshold value (between **11–86**), and then press ✓.

## Performing a Wireless Comm. Test for Measuring Signal Strength

A Wireless Communication test result (the signal strength between the wireless device and the main panel) must be higher than the background noise measured at the main panel. If the background noise level is higher, you will most likely need to move the wireless device to a better location.

➤ **To perform a Wireless Communication test:**

1. Exit the installer Programming menu (see *Step 2: Exiting Installer Programming Menu after Initial System Configuration*, page 49).
2. Ensure all wireless devices are activated.
3. Enter the installer code (default is **1111**), and then press **OK (✓)**.
4. Scroll to **Maintenance**, then press ✓; you are in installer Maintenance menu.
5. Scroll to **Wireless Test**, then press ✓; Zones displays.
6. At Zones, press ✓; Comm. Test displays.
7. At Comm. Test, press ✓.
8. Scroll through all wireless zones to view each of their results. The test results range from **11** (lowest) to **86** (highest), and display as per this example:

ZONE 025 001) ZONE 025:86
------------------------------

**EXPLANATION:**

001= Wireless device index number, 025=zone,; 86 = result (signal strength)

## Step 7: Configuring System Communication

### Defining Primary Communication Channels & Parameters

➤ To define the primary communication channel:

1. From **installer Programming** menu go to: **5) Communication menu > 1) Method**
2. Scroll to the primary comm. channel (**GSM**, or **IP/Wi-Fi**) then press **OK (✓)**.
3. Scroll through the respective parameters (see table below), and define the relevant ones, pressing **✓** after each parameter that is set.

#### NOTES:

- For setting the backup communication channel to the monitoring station, see *Defining Monitoring Station Account Parameters*, page 45.
- LightSYS Plus menus reflect only the communication modules that are installed.
- To establish GPRS communication, a SIM card must be installed.
- For IP communication, you can set it to Dynamic IP or Static IP (see Setting Dynamic IP / Static IP, page 30).

Primary Channel	Parameters
GSM	<p>1) <b>Timers &gt; 1)GSM Lost, 2)GSM Net Loss, 3)SIM Expire, 4)MS Polling</b> [Primary, Secondary, Backup]</p> <p>2) <b>GPRS &gt; 1)APN Code, 2)APN User Name, 3) APN Password</b></p> <p>3) <b>Email &gt; 1)Mail Host, 2)SMTP Port, 3)Email Address, 4)SMTP UserName, 5)SMTP Password</b></p> <p>4) <b>Controls &gt; 1)Caller ID (Y/N)</b></p> <p>5) <b>Parameters &gt; 1)PIN Code, 2)SIM Number, 3)SMS Centre PH, 4) GSM RSSI</b> [Disable, Low signal, High signal]</p> <p>6) <b>Prepay SIM &gt; 1)Get Credit By</b> [Credit SMS, Credit Voice, Service Cmnd], 2)PN To Send, 3)PN to Receive, 4)SMS Message</p>
IP	<p>1) <b>IP Config &gt; 1)Obtain IP</b> [Dynamic IP, Static IP], 2)Panel Port, 3)Panel IP, 4)Subnet Mask, 5)Gateway, 6)DNS Primary, 7)DNS Secondary, 8)Wi-Fi Scan, 9)Add Wi-Fi Net, 10)WPS Button</p> <p>2) <b>E-mail</b> [Mail Host, SMTP Port, Email Address, SMTP Name, SMTP Password, Encryption]</p> <p>3) <b>Host Name</b> [Security_System]</p> <p>4) <b>MS Polling</b> [Primary, Secondary, Backup]</p>

## Defining Communication with the Monitoring Station

You enable and define communication settings for monitoring station account(s), along with the backup communication channel and other associated parameters that define the nature of communication, event reporting and confirmation between the system and the monitoring station. Monitoring station link-up options are via TCP/IP, and GSM/GPRS.

### Enabling Monitoring Station Communication

- **To enable monitoring station communication:**
  1. From **installer Programming menu** go to: **1)System > 2)Controls > 3)Communication > 1)MS Enable**.
  2. Press  to scroll to **Y**, and then press **OK (✓)**.

### Defining Monitoring Station Account Parameters

- **To define parameters for a monitoring station account:**
  1. From **installer Programming menu** go to: **5)Communication > 2) MS > 1)Report Type**; MS1 (MS account 1) displays.
  2. Scroll to the MS account number you want to define, and then press **OK (✓)**.
  3. Scroll to select the reporting type (**Voice, IP, SMS, SIA IP**), and then press **✓**; the available primary/backup communication channel options appear (according to the primary communication channel already selected).
  4. Scroll to select from the primary/backup communication channel options, and then press **✓**. Note that if “GSM Only,” or “IP Only” is selected, it will not have a backup communication channel.
  5. Enter parameters as needed, and then press **✓**.
  6. Go to: **5)Communication > 2)MS > 2)Accounts**, scroll to select an account number to define, enter its account number, and then press **✓**.
  7. Go to: **5)Communication > 2)MS > 3)Comm Format**, and then press **✓**. Scroll to select a transmission format (**Contact ID or SIA**), and then press **✓**.
  8. Go to: **5)Communication > 2)MS >** scroll to and define other options as needed: **4)Controls, 5)Parameters, 6)MS Times, 7)Report Split, 8)Report Codes**.
  9. Repeat the procedure for all other monitoring station accounts used.

## Step 8: Configuring Cloud Connectivity

The RISCO Cloud is RISCO's application server that handles all communication between the system, monitoring station, as well as system users (for Smartphone, Web app, and Follow-Me). Cloud communication enables remote monitoring and control of the system, sending event notifications, zone licensing and viewing real-time video verification via RISCO's VUpoint IP cameras.

### Enabling / Disabling Cloud Communication

The system is Cloud-enabled by default.

➤ **To enable or disable Cloud communication:**

1. From the **installer Programming menu** go to: **1)System > 2)Controls > 3)Communication > 4)Cloud Enable [N/Y]**.
2. Press  to toggle between **Y** and **N** to enable/disable Cloud communication, and then press **✓**.

### Defining RISCO Cloud Connectivity

If using IP and/or GSM modules, you need to define the network connectivity to the RISCO Cloud server.

➤ **To define network connectivity to the RISCO Cloud:**

1. With Cloud communication enabled, from **installer Programming menu** go to: **5)Communication menu > 5)Cloud**
2. Scroll to, and define parameters for the following as needed (note that customer-specific parameters may differ):
  - **1) IP Address:** (default is **riscocloud.com**)
  - **2) IP Port:** (default is **33000**)
  - **3) Password:** Password for server access (default is **AAAAAA**).
  - **4) Channel:** Select **IP Only** or **GSM Only**, depending on the installed communication modules in the panel.
  - **5) Controls:** Press  to toggle between **Y** and **N** to enable/disable MS Call All, FM Call All, App Arm, and App Disarm.

## Step 9: Configuring Common System Parameters

### Defining System Users

As the installer, you must set up permissions for all the system users – the partitions each user is allowed to operate, and the authority level for each user, and designate the code length (see the *LightSYS Plus Installation and Programming Manual*), however the Grand Master will set the actual numerical codes for each user. The installer can also change default installer, sub-installer and Grand Master codes.

### Defining User Codes

➤ **To define user codes:**

1. From **installer Programming menu** go to: **4)Codes > 1)User**, then press ✓.
2. Scroll to a user's index number (1–500 users possible), then press ✓; the user number and "1) Partition" display.
3. Press ✓. To assign the partition(s) this user will be allowed to operate, do the following:
  - a. While scrolling through each block of 10 partitions, select partition(s) to allow operation by this user by entering a partition number to select it (it will display), or by entering the number again to clear it (it will not display).
  - a. When finished selecting all partition numbers press ✓.
4. To assign an authority level for this user, do the following:
  - a. After assigning partitions (step 3), scroll to **2)Authority**, then press ✓.
  - b. Press  to go to the authority level for this user (**User, Arm Only, Maid, Unbypass, Guard, Duress, UO Control, Master**), then press ✓.

### Changing the Default Installer Code

The default installer code is **1111**. You can either use this code during system programming, or you can change it.

➤ **To change the installer code:**

1. From the **installer Programming menu** select **4)Codes > 3)Installer**, and then press **OK** (✓); CODE: 1111 displays.
2. Scroll to each digit and enter a new code, then press ✓.
3. Re-enter the new code, and then press ✓.

## Changing the Default Grand Master Code

The default Grand Master code is **1234**, which can be changed by the installer. Be sure to advise the customer that that after system installation, the primary system user (“Grand Master”) should change the Grand Master code to be unique and confidential (refer to the LightSYS Plus User documentation).

### ➤ To change the default Grand Master code:

1. From the **installer Programming menu** select **4)Codes > 2)Grand Master**, and then press **OK (✓)**; \*\*\*\* displays
2. Scroll through the asterisks and enter a new code, and then press **✓**.

## Defining Follow Me Destinations

You can enable and define multiple Follow-Me destinations.

**NOTE:** The actual telephone numbers and email addresses for FM destinations are defined by the Grand Master in the User menu.

## Enabling Follow Me

### ➤ To enable using Follow Me destinations:

- From the **installer Programming menu** go to: **1)System > 2)Controls > 3)Communication > 2)FM Enable**, use  to toggle to **Y** to enable (or to **N** to disable), and then press **OK (✓)**.

## Defining Follow Me Parameters

### ➤ To define parameters for a Follow Me destination:

1. From the **installer Programming menu** go to: **5)Communication menu > 4)Follow Me > 1)Define FM**; Follow Me 01 displays (1st FM destination).
2. Scroll to a FM number to define, and then press **✓**.
3. Scroll through the following options and define them as needed: **Report Type, Partition, Events, Restore Events, Remote Control**.

## Defining System Timers

You can change the system defaults for the various system timers, as needed. See the *LightSYS Plus Installation and Programming Manual* for details.

### ➤ To define system timers:

1. From the **installer Programming menu**, select **1)System > 1)Timers**
2. Scroll to select from the options and modify their parameters as needed.



## INSTALLER PROGRAMMING

### Step 1: Defining Additional Parameters in the Installer Programming Menu





For additional system parameters (from the installer Programming menu), program them as needed. See the *LightSYS Plus Installation and Programming Manual*.

### Step 2: Exiting Installer Programming Menu after Initial System Configuration

**IMPORTANT:** After programming at initial system setup from the installer Programming menu, you must exit it. Then you can then program additional parameters as needed from the other installer menus.

➤ **To exit installer Programming menu after initial system programming:**

**⚠ WARNING:** In the main panel box/enclosure do not touch any AC electrical wiring to/from the mains fuse terminals nor the mains fuse terminals, as 230 VAC can result in electric shock and death.

1. Close the main panel box/enclosure in order to prevent a front tamper alarm.
2. Press  on keypad repeatedly to go to the beginning of the current menu.
3. Press 0 to exit, toggle with  to Y to save all your programming settings, and then press ✓; TAMPER TESTING displays as the system checks for tamper trouble conditions.
4. If an alarm sounds and you want to quit with a current tamper trouble condition, press , press  to toggle to Y (yes), and then press ✓.  
If you select N (no), you will not be able to exit Programming mode until the tamper trouble condition has been restored to normal.

### Step 3: Defining Parameters in other Installer Menus

After performing the Exiting Installer Programming Menu procedure, you can access other installer menus to define parameters, as needed (see the *LightSYS Plus Installation and Programming Manual*).

## Testing the System

It is important to fully test the system. Here are typical, recommended system tests. See the *LightSYS Plus Installation and Programming Manual* for more test information.

- ✓ Bus Test for bus communication quality. See page 28.
- ✓ Background noise-level threshold & calibration for wireless devices. See page 42.
- ✓ Wireless Communication Test for wireless devices. See page 43.
- ✓ Walk Test (for zones) – during which you arm the system, and then enter the protected area in order to trigger alarm events at each detector to ensure operability. Go to: **installer Maintenance menu > Walk test**
- ✓ Monitoring Station (MS) Test (see the *LightSYS Plus Installation Manual*)
- ✓ GSM signal strength – go to **installer Maintenance menu > Diagnostics > GSM > Signal** – and view the signal strength result (0–5).
- ✓ Additional tests at **installer Maintenance menu** for keypads, sirens, strobes, wireless, and diagnostics (including main battery test, and zone resistance test)
- ✓ Follow-Me Test: After programming FM destination(s), go to: **User Menu > Follow Me > Test FM**. Trigger an alarm activation (for example, as done during a Walk Test), and see if the FM notification is received at the FM destination.

## Installer Responsibilities for Assisting Clients

Here are some typical, recommended areas for you to assist the client:

- ✓ Advise client to change the Grand Master code to one that is confidential
- ✓ For RISCO Cloud-enabled communication, instruct users with Smartphones to download the iRISCO App from the Apple App store or Android Play Store, and ensure that a connection between the app and the system is established.
- ✓ Instruct how to define user codes, proximity tags, and Follow-Me contacts.
- ✓ Instruct how to do the following from keypads and keyfobs:
  - Full arm, partial arm, and disarm
  - Send a duress disarm (silent alarm) to the monitoring station
  - Activate a panic alarm
  - Check system status
  - Use SMS for remote operation
  - Operate Talk 'n Listen

# Technical Specification

Main Panel	Technical Information
Input Power:	AC/DC Adaptor 100-240 V, 50/60Hz 14.4V (+/-5%) – 2.5-4.5A PS
Current Consumption:	110 mA, typical, 180 mA, maximum
Rechargeable Standby Battery:	12 V, 21Ah (Amp-hours)
Output Voltage Range	11V – 13.8V (ripple 200 mV)
Power Output	<ol style="list-style-type: none"> <li>1. Maximum current draw from each bus (“AUX RED” terminals is 500 mA</li> <li>2. Maximum current draw from Bell/LS terminal is 500 mA</li> <li>3. Maximum current draw from the AUX terminal 1A</li> </ol>
Programmable outputs:	<b>UO1:</b> Dry contact relay (24V, 1 Amp) <b>UO2:</b> 500 mA transistor (Open Collector) <b>UO3 – UO4:</b> 100 mA, opto relay
Main Box/Enclosure Dimensions	RP512BM21 375 x 330 x 98 mm RP512BM26 420 x 379 x 95 mm RP512B 403 x 321.5 x 115.5 mm
Operating temperature	-10°C to 55°C (14°F to 131°F)
Keypads, Expansion Modules, Communication Modules	Technical Information
RisControl Keypad (RP432KPT)	13.8V ±10%, 170 mA, 5W max.
Panda Wired LCD Keypad, Proximity (RP432KPP2)	13.8 V +/-10%, 130 mA typical, 180 mA maximum
Panda Wired LCD Keypad (RP432KP02)	13.8 V +/-10%, 130 mA typical, 180 mA maximum
WL Panda Keypad for LightSYS, 868 (RW432KPP)	9µA mA standby current, 150 mA maximum
Elegant Keypad (RPKEL)	12 V +/-15%, 100 mA maximum
Elegant Keypad – Proximity (RPKELP)	12 V +/-15%, 150 mA maximum
LCD Keypad (RP432KP)	13.8 V +/-10%, 48 mA typical, 52 mA maximum
Proximity LCD Keypad (RP432KPP)	13.8 V +/-10%, 62 mA typical, 130 mA maximum
Single Zone Expander (RP128EZ1)	13.8 V DC +/-10%; 20 mA
8 Zone Expansion Module (RP432EZ8)	13.8 V DC +/-10%; 20 mA, typical, 29mA maximum
Bus Zone Expander (RP128EZB)	13.8 V DC +/-10%; 20 mA
Wireless Video Expander (RP432EWV)	13.8 V DC +/-10%; 40 mA typical; 65 mA maximum
Wireless Security Module (RP432EWS)	13.8 V DC +/-10%; 40 mA typical; 65 mA maximum
Wireless Expansion Module (RP432EW8, RP432EW4)	13.8 V DC +/-10%; 40 mA typical, 65 mA maximum
4 x 3A relay output expansion module (ProSYS E04)	13.8VDC +/-10%; 25 mA typical / 160 mA maximum 4 Form C (SPDT) Relays.; 5 A / 24V DC
[Italy] Prox. Key Reader (ProSYS PKR3)	13.8 V DC +/-10%; 70 mA, typical, 180 mA maximum
Digital Voice Module (RP432EV)	13.8 V DC +/-10%; 30 mA typical, 70 mA maximum
Listen & Speak Unit (RP128EVM)	13.8 V DC +/-10%; 10mA standby, 60mA typical, 130 mA maximum
Plug-in multi-socket 2G GSM Module (RP512G2)	30 mA standby, 300 mA communicating

<b>Plug-in multi-socket 3G GSM Module (RP512G3)</b>	30 mA standby, 300 mA communicating
<b>Plug-in multi-socket 4G GSM Module in plastic box (RP432G4)</b>	30 mA standby, 300 mA communicating
<b>3A Supervised Switching PS Expansion modules (ProSYS 3APS, ProSYS 3APSB)</b>	Input: 16.5 V AC @ 50 VA (via 230 V AC – 16.5 V AC transformer) Aux output: 3 A @ 13 VDC; Bell/LS (external) sounder output: 1.7 A @ 13 V DC



## Standard Limited Product Warranty

RISCO Ltd., its subsidiaries and affiliates (“**Risco**”) guarantee Risco’s hardware products to be free from defects in materials and workmanship when used and stored under normal conditions and in accordance with the instructions for use supplied by Risco, for a period of (i) 24 months from the date of connection to the Risco Cloud (for cloud connected products) or (ii) 24 months from production (for other products which are non-cloud connected), as the case may be (each, the “**Product Warranty Period**” respectively).

**Contact with customers only.** This Product Warranty is solely for the benefit of the customer who purchased the product directly from Risco, or from any authorized distributor of Risco. Nothing in this Warranty obligates Risco to accept product returns directly from end users that purchased the products for their own use from Risco’s customer or from any installer of Risco, or otherwise provide warranty or other services to any such end user. Risco customer shall handle all interactions with its end users in connection with the Warranty, inter alia regarding the Warranty. Risco’s customer shall make no warranties, representations, guarantees or statements to its customers or other third parties that suggest that Risco has any warranty or service obligation to, or any contractual privity with, any recipient of a product.

**Return Material Authorization.** In the event that a material defect in a product shall be discovered and reported during the Product Warranty Period, Risco shall, at its option, and at customer’s expense, either: (i) accept return of the defective Product and repair or have repaired the defective Product, or (ii) accept return of the defective Product and provide a replacement product to the customer. The customer must obtain a Return Material Authorization (“**RMA**”) number from Risco prior to returning any Product to Risco. The returned product must be accompanied with a detailed description of the defect discovered (“**Defect Description**”) and must otherwise follow Risco’s then-current RMA procedure in connection with any such return. If Risco determines in its reasonable discretion that any Product returned by customer conforms to the applicable warranty (“**Non-Defective Products**”), Risco will notify the customer of such determination and will return the applicable Product to customer at customer’s expense. In addition, Risco may propose and assess customer a charge for testing and examination of Non-Defective Products.

**Entire Liability.** The repair or replacement of products in accordance with this warranty shall be Risco’s entire liability and customer’s sole and exclusive remedy in case a material defect in a product shall be discovered and reported as required herein. Risco’s obligation and the Warranty are contingent upon the full payment by customer for such Product and upon a proven weekly testing and examination of the product functionality.

**Limitations.** The Product Warranty is the only warranty made by Risco with respect to the Products. The warranty is not transferable to any third party. To the maximum extent permitted by applicable law, the Product Warranty does not apply and will be void if: (i) the conditions set forth above are not met (including, but not limited to, full payment by customer for the product and a proven weekly testing and examination of the product functionality); (ii) if the Products or any part or component thereof: (a) have been subjected to improper operation or installation; (b) have been subject to neglect, abuse, willful damage, abnormal working conditions, failure to follow Risco’s instructions (whether oral or in writing); (c) have been misused, altered, modified or repaired without Risco’s written approval or combined with, or installed on products, or equipment of the customer or of any third party; (d) have been damaged by any factor beyond Risco’s reasonable control such as, but not limited to, power failure, electric power surges, or unsuitable third party components and the interaction of software therewith or (e) any delay or other failure in performance of the product attributable to any means of communications, provided by any third party service provider (including, but not limited to) GSM interruptions, lack of or internet outage and/or telephony failure.

**BATTERIES ARE EXPLICITLY EXCLUDED FROM THE WARRANTY AND RISCO SHALL NOT BE HELD RESPONSIBLE OR LIABLE IN RELATION THERETO, AND THE ONLY WARRANTY APPLICABLE THERETO, IF ANY, IS THE BATTERY MANUFACTURER’S WARRANTY.**

Risco makes no other warranty, expressed or implied, and makes no warranty of merchantability or of fitness for any particular purpose. For the sake of good order and avoidance of any doubt:



**DISCLAIMER.** EXCEPT FOR THE WARRANTIES SET FORTH HEREIN, RISCO AND ITS LICENSORS HEREBY DISCLAIM ALL EXPRESS, IMPLIED OR STATUTORY, REPRESENTATIONS, WARRANTIES, GUARANTEES, AND CONDITIONS WITH REGARD TO THE PRODUCTS, INCLUDING BUT NOT LIMITED TO ANY REPRESENTATIONS, WARRANTIES, GUARANTEES, AND CONDITIONS OF MERCHANTABILITY, FITNESS FOR A PARTICULAR PURPOSE, TITLE AND LOSS OF DATA. WITHOUT LIMITING THE GENERALITY OF THE FOREGOING, RISCO AND ITS LICENSORS DO NOT REPRESENT OR WARRANT THAT: (i) THE OPERATION OR USE OF THE PRODUCT WILL BE TIMELY, SECURE, UNINTERRUPTED OR ERROR-FREE; (ii) THAT ANY FILES, CONTENT OR INFORMATION OF ANY KIND THAT MAY BE ACCESSED THROUGH THE PRODUCT BY CUSTOMER OR END USER SHALL REMAIN SECURED OR NON DAMAGED. CUSTOMER ACKNOWLEDGES THAT NEITHER RISCO NOR ITS LICENSORS CONTROL THE TRANSFER OF DATA OVER COMMUNICATIONS FACILITIES, INCLUDING THE INTERNET, GSM OR OTHER MEANS OF COMMUNICATIONS AND THAT RISCO'S PRODUCTS, MAY BE SUBJECT TO LIMITATIONS, DELAYS, AND OTHER PROBLEMS INHERENT IN THE USE OF SUCH MEANS OF COMMUNICATIONS. RISCO IS NOT RESPONSIBLE FOR ANY DELAYS, DELIVERY FAILURES, OR OTHER DAMAGE RESULTING FROM SUCH PROBLEMS.

RISCO WARRANTS THAT ITS PRODUCTS DO NOT, TO THE BEST OF ITS KNOWLEDGE, INFRINGE UPON ANY PATENT, COPYRIGHT, TRADEMARK, TRADE SECRET OR OTHER INTELLECTUAL PROPERTY RIGHT

IN ANY EVENT RISCO SHALL NOT BE LIABLE FOR ANY AMOUNTS REPRESENTING LOST REVENUES OR PROFITS, PUNITIVE DAMAGES, OR FOR ANY OTHER INDIRECT, SPECIAL, INCIDENTAL, OR CONSEQUENTIAL DAMAGES, EVEN IF THEY WERE FORESEEABLE OR RISCO HAS BEEN INFORMED OF THEIR POTENTIAL.

Risco does not install or integrate the product in the end user security system and is therefore not responsible for and cannot guarantee the performance of the end user security system which uses the product.

Risco does not guarantee that the product will prevent any personal injury or property loss by burglary, robbery, fire or otherwise; or that the product will in all cases provide adequate warning or protection.

Customer understands that a correctly installed and maintained alarm may only reduce the risk of burglary, robbery or fire without warning, but is not an assurance or a guarantee that such an event will not occur or that there will be no personal injury or property loss as a result thereof. Consequently Risco shall have no liability for any personal injury, property damage or loss based on a claim that the product fails to give warning.

No employee or representative of Risco is authorized to change this warranty in any way or grant any other warranty.

## RED Compliance Statement

Hereby, RISCO Group declares that this equipment is in compliance with the essential requirements and other relevant provisions of Directive 2014/53/EU. For the CE Declaration of Conformity please refer to our website: [www.riscogroup.com](http://www.riscogroup.com)



## Contacting RISCO Group

RISCO Group is committed to customer service and product support. You can contact us through our website [www.riscogroup.com](http://www.riscogroup.com) or via the following RISCO branches:

**Belgium (Benelux)**

Tel: +32-2522-7622  
support-be@riscogroup.com

**China (Shanghai)**

Tel: +86-21-52-39-0066  
support-cn@riscogroup.com

**France**

Tel: +33-164-73-28-50  
support-fr@riscogroup.com

**Israel**

Tel: +972-3-963-7777  
support@riscogroup.com

**Italy**

Tel: +39-02-66590054  
support-it@riscogroup.com

**Spain**

Tel: +34-91-490-2133  
support-es@riscogroup.com

**United Kingdom**

Tel: +44-(0)-161-655-5500  
support-uk@riscogroup.com

**USA**

Tel: +1-631-719-4400  
support-usa@riscogroup.com

This RISCO product was purchased at:



© RISCO Group 2021. All rights reserved. No part of this document may be reproduced in any form without prior written permission from the publisher.