



ESS 7.0 | 9.0 | X

OPERATING MANUAL



Operating Manual ESS 7.0 | ESS 9.0 | ESS X

Document #30085-1

Version 1.7

Translation of original operating manual (German)



## Copyrights

Version 3/2019

Copyright © BMZ GmbH

Subject to technical modifications that are required for advancements.

This operating manual or parts thereof may not be reproduced in any format (photocopy, micro film or other methods) or used, duplicated or processed with the help of electronic systems without a written consent of BMZ GmbH. In case of violations of these regulations, we reserve the right to claim damage compensation.

---

## BMZ Germany

BMZ GmbH  
Am Sportplatz 28  
63768 Karlstein am Main

Phone: +49 (0) 6188 9956 0  
Service: +49 (0) 6188 9956 9830  
Fax: +49 (0) 6188 9956 699  
Website: [www.bmz-group.com](http://www.bmz-group.com)  
Service-Website: [www.bmz-central-service.com](http://www.bmz-central-service.com)  
Email: [CS.BigPack@bmz-group.com](mailto:CS.BigPack@bmz-group.com)

---

## BMZ USA

BMZ USA Inc.  
1429 Miller Store Road  
Virginia Beach, Virginia, 23455-3324

Phone: +1 757 821 8494  
Fax: +1 757 821 8499  
Email: [Service.USA@bmz-group.com](mailto:Service.USA@bmz-group.com)

## About this manual

---

### General

A qualified electrician must carry out installation, commissioning and maintenance. Please read this operating manual carefully to ensure a fault-free operation of the BMZ ESS battery storage system.

Please store this operating manual such that it is accessible to all persons who work on the BMZ ESS system.

---

### Scope

This manual is intended for all products of the BMZ ESS series

- BMZ ESS 7.0
    - Art. No. 24930-xx
    - Art. No. 30110-xx
    - Art. No. 30890-xx
    - Art. No. 30891-xx
    - Art. No. 30892-xx
    - Art. No. 31555-xx
    - Art. No. 31560-xx
    - (Art. No. 32905-xx)
  - BMZ ESS 9.0
    - Art. No. 32370-xx
    - Art. No. 33741-xx
  - BMZ ESS X
    - Art. Nr. 37400-xx
    - Art. Nr. 37401-xx
- 

### Differentiation between an operating company and operator

The end consumer is referred to as an operating company in this manual. The system is installed and put into operation for this operating company.

A person, who works on the system or its controllers, is referred to as an operator in this manual. This person must be a qualified electrician authorised by BMZ GmbH.

---

### Liability exclusion

BMZ GmbH does not bear any liability for damage resulting from unintended usage and non-adherence to this manual. This includes personal injuries, material damage, damage to the product as well as consequential damage, repair damage and other handling of the product by non-qualified electricians. This liability limitation is applicable even when non-original spare parts are used.

Carrying out arbitrary changes or technical modifications in the product is strictly prohibited.

A liability for profits lost or other costs and financial losses is ruled out.

# Table of contents

<b>About this manual .....</b>	<b>4</b>
<b>Table of contents.....</b>	<b>5</b>
<b>List of figures.....</b>	<b>8</b>
<b>1 Safety .....</b>	<b>10</b>
<b>1.1 Classification of warnings and intended use.....</b>	<b>10</b>
1.1.1 Warnings in the operating manual.....	10
1.1.2 Intended use .....	11
<b>1.2 Safety instructions to be followed .....</b>	<b>12</b>
1.2.1 General safety instructions .....	12
1.2.2 Safety instructions when working with the tool .....	13
1.2.3 Safety instructions for transport and installation .....	13
1.2.4 Safety instructions for operation .....	14
1.2.5 Safety instructions for cleaning.....	16
1.2.6 Safety instructions for maintenance and dismantling .....	16
1.2.7 Safety instructions for battery interiors .....	18
1.2.8 Safety instructions for fire prevention .....	19
1.2.9 Explosion protection .....	20
1.2.10 Residual risks.....	20
<b>1.3 Data and safety devices of the battery storage system.....</b>	<b>20</b>
1.3.1 General hazard instructions and pictograms .....	20
1.3.2 Installed safety systems .....	21
1.3.3 Safety checks.....	22
<b>2 Function, delivery scope and technical key variables .....</b>	<b>23</b>
<b>2.1 Function.....</b>	<b>23</b>
<b>2.2 Delivery scope.....</b>	<b>23</b>
<b>2.3 System overview .....</b>	<b>23</b>
<b>2.4 Rating plates and warning stickers.....</b>	<b>25</b>
<b>2.5 Technical key variables.....</b>	<b>27</b>
<b>3 Transport .....</b>	<b>28</b>
<b>3.1 Safety instructions for transport.....</b>	<b>28</b>
<b>3.2 Transporting the battery storage system.....</b>	<b>28</b>
<b>4 Installation, assembly and commissioning for the first time .....</b>	<b>32</b>
<b>4.1 Installation site requirements .....</b>	<b>32</b>
<b>4.2 Filling the installation check list.....</b>	<b>33</b>
<b>4.3 Installation of the battery storage system.....</b>	<b>34</b>
<b>4.4 Preparing the electrical connections for the single mode .....</b>	<b>34</b>
4.4.1 Checking the connections .....	38
4.4.2 Switching the battery storage system on and off .....	38
4.4.3 Configuring the parameters of the inverter .....	40
<b>4.5 Preparing the electrical connections for the parallel mode .....</b>	<b>40</b>
<b>4.6 Connection concept of multiple BMZ ESS batteries with one or more battery inverters.....</b>	<b>41</b>
4.6.1 Communication .....	41

4.6.2	Contacting power cables .....	43
<b>4.7</b>	<b>Configuration of the ESS parallel mode .....</b>	<b>48</b>
4.7.1	1-phase operation of a SMA Sunny Island inverter on 1 ESS battery.....	48
4.7.2	1-phase operation of a SMA Sunny Island inverter on 2 ESS batteries .....	48
4.7.3	1-phase operation of a SMA Sunny Island inverter on 3 ESS batteries .....	49
4.7.4	3-phase operation of a SMA Sunny Island inverter on 3 ESS batteries .....	50
4.7.5	3-phase operation of a SMA Sunny Island inverter on 4 ESS batteries .....	51
4.7.6	3-phase operation of a SMA Sunny Island inverter on 5 ESS batteries .....	52
4.7.7	3-phase operation of a SMA Sunny Island inverter on 6 ESS batteries .....	53
4.7.8	3-phase operation of a SMA Sunny Island inverter on 9 ESS batteries .....	54
4.7.9	3-phase operation of a SMA Sunny Island inverter on 12 ESS batteries .....	55
<b>4.8</b>	<b>Configuration of the ESS battery .....</b>	<b>56</b>
4.8.1	System structure .....	56
4.8.2	Addressing the batteries .....	56
<b>4.9</b>	<b>Definition of the battery mode during commissioning and parameter configuration ...</b>	<b>56</b>
4.9.1	Single: .....	56
4.9.2	Master: .....	56
4.9.3	Slave: .....	56
<b>4.10</b>	<b>Work step sequence to configure the parameters of batteries.....</b>	<b>57</b>
<b>4.11</b>	<b>Work step sequence to commission the batteries .....</b>	<b>58</b>
<b>4.12</b>	<b>Configuration of firmware for parallel mode.....</b>	<b>58</b>
4.12.1	Setting the master battery mode .....	59
4.12.2	Setting the master battery address.....	59
4.12.3	Setting the slave battery mode .....	60
4.12.4	Setting the slave battery address.....	61
<b>4.13</b>	<b>Commissioning the parallel connection of multiple batteries .....</b>	<b>61</b>
4.13.1	Switch-on sequence .....	61
4.13.2	Stand-by mode of a slave battery: .....	61
4.13.3	Switch-on criterion of the slave battery:.....	61
4.13.4	Example 1: .....	62
4.13.5	Example 2: .....	63
4.13.6	Example 3: .....	63
<b>4.14</b>	<b>Checking the parallel connection of multiple batteries .....</b>	<b>64</b>
4.14.1	Check the number of connected (detected) batteries .....	64
4.14.2	Check the number of batteries for which the main relay is closed .....	65
<b>4.15</b>	<b>Adding new batteries.....</b>	<b>65</b>
<b>4.16</b>	<b>Checking the connections of parallel battery systems.....</b>	<b>65</b>
4.16.1	Switching the battery storage system on and off .....	65
4.16.2	Configuring the parameters of the inverter .....	68
<b>4.17</b>	<b>Recommended parameters of the inverter.....</b>	<b>68</b>
4.17.1	SMA Sunny Island with Sunny Control Module.....	68
4.17.2	Learning cycle.....	69
<b>5</b>	<b>Operation and service software .....</b>	<b>70</b>
<b>5.1</b>	<b>Pilot lamps (LED) .....</b>	<b>70</b>
5.1.1	LED indicators on the battery module .....	70
5.1.2	Charging status indicator .....	71
<b>5.2</b>	<b>Connection of the notebook for servicing .....</b>	<b>71</b>

5.2.1	USB port .....	71
5.2.2	Service software .....	72
<b>6</b>	<b>Fault/damage event.....</b>	<b>73</b>
<b>6.1</b>	<b>Fault indicators .....</b>	<b>73</b>
6.1.1	Fault indicators of pilot lamps.....	73
<b>6.2</b>	<b>Actions to be taken in case of a damage .....</b>	<b>73</b>
6.2.1	First aid measures .....	73
<b>7</b>	<b>Service and maintenance activities .....</b>	<b>75</b>
7.1	Complaint handling .....	76
<b>8</b>	<b>Warranty conditions .....</b>	<b>77</b>
<b>9</b>	<b>Dismantling and disposal.....</b>	<b>78</b>
9.1	Disposal of the battery storage system.....	78
<b>10</b>	<b>Annexe .....</b>	<b>79</b>
10.1	Declaration of conformity .....	80
10.2	Installation check list.....	84

## List of figures

Figure 1-1: Hazard instructions, pictograms .....	21
Figure 1-2: battery storage system, side view of NH1 isolator .....	21
Figure 2-1: delivery scope .....	23
Figure 2-2: battery storage system, front view .....	23
Figure 2-3: battery storage system, side view .....	24
Figure 2-4: battery storage system, side view .....	24
Figure 2-5: battery storage system, rear view .....	25
Figure 2-6: battery storage system, rear side .....	25
Figure 2-7: rating plate.....	26
Figure 2-8: rating plate.....	26
Figure 2-9: recycling symbol .....	26
Figure 2-10: battery storage system, recycling symbol .....	26
Figure 2-11: overview of technical specifications .....	27
Figure 3-1: seal position .....	29
Figure 3-2: seal position .....	29
Figure 3-3: transporting with the sack truck.....	31
Figure 4-1 : Requirements for the installation site, distance of the ESS from walls, top view .....	32
Figure 4-2 : Requirements for the installation site, distance of the ESS from walls, side view .....	33
Figure 4-3: representation of the pulled current isolator.....	34
Figure 4-4: inverter, connection area for battery lines.....	35
Figure 4-5: sample representation of the connection of plus and minus power cables with the SMA Sunny Island inverter .....	35
Figure 4-6: representation of external connections of the battery system, CAN .....	36
Figure 4-7: battery storage system, side view of the opened housing .....	37
Figure 4-8: representation of the correctly inserted fuses .....	37
Figure 4-9: battery storage system, side view .....	38
Figure 4-10: communication cabling, ESS parallel connection .....	42
Figure 4-11: RJ45 Y-adapter (even RJ45 T-connector) .....	42
Figure 4-12: pin assignment of RJ45 Y-adapter (T-connector).....	42
Figure 4-13: battery storage system, side view, power isolator pulled .....	43
Figure 4-14: cable lengths of the ESS system.....	44
Figure 4-15: output cable of BAT Breaker Box.....	45
Figure 4-16: BAT BREAKER Box of Enwitec (example for 6 batteries and 3 inverters) with a closed housing.....	46
Figure 4-17: BAT BREAKER Box of Enwitec (example for 6 batteries and 3 inverters) with an open housing.....	47
Figure 4-18 : 1-phase operation on 1 ESS battery .....	48
Figure 4-19: 1-phase operation on 2 ESS batteries.....	48
Figure 4-20: 1-phase operation on 3 ESS batteries.....	49
Figure 4-21: 3-phase operation on 3 ESS batteries.....	50
Figure 4-22: 3-phase operation on 4 ESS batteries.....	51
Figure 4-23: 3-phase operation on 5 ESS batteries.....	52
Figure 4-24: 3-phase operation on 6 ESS batteries.....	53
Figure 4-25: 3-phase operation on 9 ESS batteries.....	54
Figure 4-26: 3-phase operation on 12 ESS batteries.....	55
Figure 4-27: representation of the BMZ ESS service tool .....	56
Figure 4-28: representation of the work sequence to configure the parameters of a BMZ ESS battery .....	57



Figure 4-29: representation of the work sequence to commission a BMZ ESS battery .....	58
Figure 4-30: file structure of the BMZ ESS service tool.....	59
Figure 4-31: representation of configuration of the parameters of a BMZ ESS battery .....	59
Figure 4-32: representation of configuration of the parameters of a BMZ ESS battery .....	60
Figure 4-33: representation of configuration of the parameters of a BMZ ESS battery .....	60
Figure 4-34: representation of configuration of the parameters of a BMZ ESS battery .....	61
Figure 4-35: block circuit diagram of the BMZ ESS slave battery.....	62
Figure 4-36: representation of example 1, different SOC of BMZ ESS batteries connected in parallel .	62
Figure 4-37: representation of example 2, different SOC of BMZ ESS batteries connected in parallel .	63
Figure 4-38: representation of example 3, different SOC of BMZ ESS batteries connected in parallel .	63
Figure 4-39: check the number of BMZ ESS batteries connected in parallel .....	64
Figure 4-40: check the number of BMZ ESS batteries connected in parallel .....	65
Figure 4-41: SMA Parameter on-grid with Sunny Control Module .....	69
Figure 4-42: SMA Parameter off-grid with Sunny Control Module.....	69
Figure 5-1: Pilot lamps table (LED) .....	70
Figure 5-2: side view of BMZ ESS, service flap .....	71
Figure 5-3: push button with LEDs .....	71
Figure 5-4: USB communication .....	71
Figure 5-5: USB port of BMZ ESS battery, inner side of housing.....	72
Figure 5-6: push button and LEDs .....	72
Figure 10-1: EC Declaration of Conformity ESS 7.0 (1).....	80
Figure 10-2: EC Declaration of Conformity ESS 7.0 (2).....	81
Figure 10-3: EC Declaration of Conformity ESS 9.0.....	82
Figure 10-4: EC Declaration of Conformity ESS X.....	83
Figure 10-5: installation check list .....	84
Figure 10-6: installation check list, part 2 .....	85

# 1 Safety

## Target group

This section is aimed at all persons, including technical personnel, commissioning and shutdown personnel as well as personnel who work on the battery storage system.

## Background

Safety has utmost priority.

Use all aids provided to you along with the measures and processes listed in this section to ensure a safe operation.

Get a detailed information about all safety aspects.

You should be aware of the fact that hazardous situations may always arise when handling battery storage systems.

Furthermore, the use of a battery storage is associated with the residual risks under the following circumstances:

- Installation and maintenance activities are not carried out properly.
- Safety instructions given in this manual are not followed.

## 1.1 Classification of warnings and intended use

### Safety instructions

This section describe warnings in this operating manual and the intended use of the machine.

#### 1.1.1 Warnings in the operating manual



### Warnings

Warnings serve as instructions and precautionary measures that must be followed and taken to avoid a hazardous situation.

### Classification of warnings

Warnings can be classified depending on the magnitude of a hazardous situation. The classification is based on a probability assumption for an exposure to a hazardous situation and what could happen in such a case.

This manual differentiates between four warnings:

 <b>DANGER</b>	<b>“DANGER”</b> warns against hazardous situations. Prevent these hazardous situations. Otherwise, they will lead to deaths or serious injuries.
 <b>WARNING</b>	<b>“Warning”</b> warns against hazardous situations. Prevent these hazardous situations. Otherwise, they may lead to deaths or serious injuries.
 <b>CAUTION</b>	<b>“CAUTION”</b> , in combination with the warning icon, warns against hazardous situations. Prevent these hazardous situations. Otherwise, they may lead to insignificant or minor injuries.
<b>ATTENTION</b>	<b>“ATTENTION”</b> indicates a possible hazardous situation. Avoid these situations. Otherwise, they may damage the machine.

### Note



This icon draws your attention to important, useful and helpful information.

## 1.1.2 Intended use

---



### Intended use of the battery system

The BMZ ESS system must be exclusively used to store the current generated by the photovoltaic systems.

### Foreseeable misuse

Any other use is considered to be unintended. BMZ GmbH shall not be responsible for damage resulted from this. The BMZ ESS system is primarily **not** approved for the following usages:

- For a mobile use (e.g. on ships, in aeroplanes or in all types of land vehicles)
- For operation in outdoor areas
- For use in medical devices
- For use as a UPS system

 <b>DANGER</b>	
	<p><b>Possible risk to life due to unintended usage</b></p> <p>This battery system is exclusively intended for the aforementioned purpose. Any other use or a modification of the battery system without a written consent of the manufacturer is considered to be unintended. The manufacturer will not assume liability for any resultant damage. The operating company shall bear full responsibility for any risk. The battery system may be put into operation only if it is ensured that all safety devices have been installed and functioning properly. Never install or operate a potentially or obviously defective battery storage.</p> <p><b>Prevent these hazardous situations. Otherwise, they will lead to deaths or serious injuries.</b></p>

Intended usage also implies compliance with the usage and operating instructions specified by the manufacturer as well as maintenance and servicing conditions.

## 1.2 Safety instructions to be followed

---

### Safety instructions

Follow the safety instructions in this section to ensure the safety of persons and the system.

### 1.2.1 General safety instructions

---

#### Target group

These general safety instructions are intended for all operators and operating companies of the battery system. Each person, who is entrusted with the installation, commissioning, operation, cleaning, maintenance and repair activities, must have read and understood this operating manual, especially the **Safety** section.

---

#### Laws and regulations

Follow the instructions (regulations) of the relevant authorities as well as safety and operating instructions.

---

#### Spare parts

Only use original spare parts in case of repairs or when replacing the parts.



Using other parts that do not comply with our specifications may pose risks to persons and the system.





BMZ GmbH shall not be liable for personal injuries and/or material damage resulting from changes in the system.

---

#### Operator

Only a qualified electrician may operate/maintain the battery storage system.

 <b>WARNING</b>	
	<p><b>Possible risk due to inadequately qualified persons</b></p> <p>Only a qualified electrician may carry out installation, servicing and maintenance activities.</p> <p><b>Prevent these hazardous situations. Otherwise, they may lead to deaths or serious injuries.</b></p>

---

#### Suitable clothing (PPE)

Observe the following instructions regarding suitable clothing.

- Always wear protective shoes. Class S3
  - Always wear ESD protective clothing.
  - Wear suitable protective gloves.
  - Wear suitable protective goggles.
  - Do not carry electrically conductive objects (jewellery, rings, watches, chains)
- 

#### Condition of the battery storage system

Keep the battery storage system clean and in an excellent condition. Operate the battery system only if it is in a flawless condition.

---

**Other safety instructions**

Follow the detailed safety instructions in Operation, Maintenance & Dismantling and Disposal sections.

---

**1.2.2 Safety instructions when working with the tool**

---

**Target group**

These safety instructions are intended for all persons who are entrusted with the transport and installation of the battery storage system.

---



**Adhere to the operating manual**

Always follow the instructions in the operating manual.

---

**Working with tools**

Adhere to the following warning when using tools:

 <b>WARNING</b>	
	<p><b>A forgotten tool poses the risk of injuries.</b></p> <p>Do not keep any tools or metal parts on or in the battery.</p> <p>If a tool is not removed before commissioning, it may cause a short-circuit and injure persons or damage the system.</p> <ul style="list-style-type: none"><li>• Only use the completely insulated tool.</li><li>• Before commissioning/re-commissioning the battery system, ensure that there are no tools in the battery system.</li></ul> <p><b>Prevent these hazardous situations. Otherwise, they may lead to deaths or serious injuries.</b></p>

---

**1.2.3 Safety instructions for transport and installation**

---

**Target group**

These safety instructions are intended for all persons who are entrusted with the transport and installation of the battery storage system.

---

**Adhere to the operating manual**

Always follow the instructions in the operating manual.

---

**Adhere to the installation manual**

Always follow the instructions in the installation manual.

**⚠ DANGER**



**Risk of life due to live components**

There is a risk of life in case of a contact with live components.

- Only trained experts may work on the machine.
- When working on the current circuit or on the battery, always switch off the main switch first. Secure it with a padlock.
- When working on the current circuit or on the battery, always open the safety disconnection elements first. Secure the battery in which the disconnection elements are spatially separated and kept.
- Follow the 5 safety rules of battery technology.
- Never install or operate a potentially or obviously defective battery storage.

**Prevent these hazardous situations. Otherwise, they will lead to deaths or serious injuries.**

**⚠ WARNING**



**Risk due to the loss of static stability**

There is a risk of injuries due to the weight of the system.

- The system may tilt or fall in case of improper transport.
- Only use the transport aids that are suitable for the weight.
- Ensure the correct weight distribution of the system when transporting.
- The transport aids must provide a braking effect in case of a steep transport route.

**Prevent these hazardous situations. Otherwise, they may lead to deaths or serious injuries.**

**⚠ WARNING**



**Risk of injuries due to improper operation**

Only trained experts may work on the system.

- In case of maintenance and repair activities, the danger area is extended by 1 m around the system. Pay attention to the swivel range of the opening flap.
- The operating company must ensure that the access to the danger area is prevented during the movement sequences.

**Prevent these hazardous situations. Otherwise, they may lead to deaths or serious injuries.**

## 1.2.4 Safety instructions for operation

### Target group

These safety instructions are intended for all persons who are authorised to operate the battery storage system.

### Adhere to the operating manual

Always follow the instructions in this operating manual when operating the battery storage system.

**Safety instructions for operation**

Only use original parts of the manufacturer or the components approved by the manufacturer for the energy storage unit.

**⚠ DANGER****Risk of life due to live components**

When working on the electrical device, you may come in direct contact with parts carrying electric potential. Such a direct contact causes an electric shock.

- Follow the 5 safety rules of battery technology.
- Furthermore, only experts may maintain, modify or dismantle the battery storage system.
- Never install or operate a potentially or obviously defective battery storage.

**Prevent these hazardous situations. Otherwise, they will lead to deaths or serious injuries.**

**⚠ DANGER****Danger due to erupting fire (electric hazard)**

Fire may erupt during operation due to sparks or heated surfaces.

- Follow the corresponding safety regulations (5 safety rules).
- Furthermore, only experts may maintain, modify or dismantle the battery storage system.
- Never install or operate a potentially or obviously defective battery storage.

**Prevent these hazardous situations. Otherwise, they will lead to deaths or serious injuries.**

**⚠ WARNING****Health hazards due to negligent use of personal protective equipment**

Working without personal protective equipment may cause serious injuries.

- Wear personal protective equipment (PPE).

**Prevent these hazardous situations. Otherwise, they may lead to deaths or serious injuries.**

**⚠ WARNING**



**Danger due to burns (electric hazard)**

When working on the electrical device, you may come in direct contact with defective and/or overloaded parts and get burns.

- Follow the 5 safety rules of battery technology.
- Furthermore, only experts may maintain, modify or dismantle the battery storage system.

**Prevent these hazardous situations. Otherwise, they may lead to deaths or serious injuries.**

### 1.2.5 Safety instructions for cleaning

---

#### Target group

These safety instructions are intended for all persons who are authorised to clean the battery storage system.

---

#### Adhere to the operating manual

Always follow the instructions in the operating manual when cleaning the battery storage system.

---

#### Safety instructions for cleaning

**ATTENTION**



**Risk of damaged machine**

- Never clean the system or system parts using a vapour jet or spray water. Dirt and water may enter the system and cause major damage.
- Use only a moist and clean cotton cloth for cleaning.

**Avoid these situations. Otherwise, they may damage the machine.**

### 1.2.6 Safety instructions for maintenance and dismantling

---

#### Target group

These safety instructions are intended for all persons who are authorised to maintain/dismantle the battery storage system.

---

#### Adhere to the operating manual

Always follow the instructions in this operating manual when maintaining/dismantling the battery storage system.

---

#### Safety instructions for maintenance/dismantling

Observe the following warning when working on the electrical device:



**⚠ DANGER**



**Risk of life due to live components**

There is a risk of life in case of a contact with live components.

- Only trained experts may work on the system.
- When working on the current circuit or on the battery, always switch off the main switch first. Secure it with a padlock.
- When working on the current circuit or on the battery, always open the safety disconnection elements first. Secure the battery in which the disconnection elements are spatially separated and kept.
- Pay attention to the risk of electric arcs when pulling the NH1 isolator under the full load of the battery
- Follow the 5 safety rules of battery technology.

**Prevent these hazardous situations. Otherwise, they will lead to deaths or serious injuries.**

**⚠ DANGER**



**Risk due to falling and being slung away**

When working on the electrical device, a person may fall or slung away due to a contact with parts carrying electric potential or parts with electrostatic charges.

- Follow the corresponding safety regulations
- Furthermore, only experts may maintain, modify or dismantle the switch cabinet.

**Prevent these hazardous situations. Otherwise, they will lead to deaths or serious injuries.**

**⚠ DANGER**



**Danger due to erupting fire (electric hazard)**

Fire may erupt during operation due to sparks or heated surfaces.

- Follow the corresponding safety regulations (5 safety rules).
- Furthermore, only experts may maintain, modify or dismantle the switch cabinet.

**Prevent these hazardous situations. Otherwise, they will lead to deaths or serious injuries.**

**⚠ WARNING**



**Health hazards due to negligent use of personal protective equipment**

Working without personal protective equipment may cause serious injuries.

- Wear personal protective equipment (PPE).

**Prevent these hazardous situations. Otherwise, they may lead to deaths or serious injuries.**

**⚠ CAUTION****Danger due to burns (electric hazard)**

When working on the electrical device, you may come in direct contact with defective and/or overloaded parts and get burns.

- Follow the corresponding safety regulations
- Furthermore, only experts may maintain, modify or dismantle the switch cabinet.
- Pay attention to the risk of electric arcs when pulling the NH1 isolator under the full load of the battery

**Prevent these hazardous situations. Otherwise, they may lead to insignificant or minor injuries.**

## 1.2.7 Safety instructions for battery interiors

---

**Target group**

These safety instructions are intended for all persons who are authorised to work on battery modules of the battery storage system.

---

**Adhere to the operating manual**

Always follow the instructions in the operating manual and in the specifications when working on these modules.

---

**Safety instructions for battery module****⚠ DANGER****Danger due to leaking electrolyte**

Only the trained experts and persons qualified and approved by BMZ GmbH may work on the battery. Modifications or manipulations in the battery may lead to considerable safety risks and are therefore prohibited.

- Do not solder cables to the battery.
- Do not short circuit the battery.
- Never open, dismantle, drill and crush the battery.
- Never allow the battery to fall.
- Do not expose batteries to rain or dip them in liquids.
- Do not touch damaged batteries with bare hands. Lithium can cause severe skin burns. Handle damaged batteries with suitable safety equipment and tools.
- Do not use defective, damaged or leaked batteries.
- Do not use batteries that show discolouration, deformations, unusual noises or severe heat.

**Prevent these hazardous situations. Otherwise, they will lead to deaths or serious injuries.**

**⚠ DANGER**



**Danger due to leaking electrolyte**

The materials / mediums to be used for intended operation of the battery storage system are procured and used by the manufacturer of the system. The manufacturer is thus solely responsible for the proper handling of these materials / mediums and the associated hazards. Hazard and disposal instructions must be provided by the manufacturer. Follow the safety data sheets of material and medium manufacturers.

**Prevent these hazardous situations. Otherwise, they will lead to deaths or serious injuries.**

### 1.2.8 Safety instructions for fire prevention

---

#### Fire protection

Take essential precautions to respond efficiently in case of a fire.

---

#### Instructions for fire prevention

Pay attention to the following points:

Keep the fire extinguisher(s) in the immediate vicinity of the system. (Fire extinguisher of fire class D)  
 Also keep in mind that poisonous vapours may be developed due to burning batteries and may hamper and damage the function of respiratory tracts.

---

#### Hazard due to fire

The battery storage system does not pose a fire hazard. In case of a fire in the system, avoid its spreading to other objects.  
 The battery storage system is de-energised at the time of delivery. Internal connection poles are always live. Therefore, ensure that a tool or a metallic object is not kept in the battery system. This could lead to a short-circuit and severe heat formation, which in turn could cause an explosion.

---

#### Actions to be taken in case of a damage

**⚠ WARNING**



**Possible risk of life due to electric shock when quenching fire or due to flooding.**

If you do not observe the following behavioural instructions, they may cause material damage and personal injuries; BMZ GmbH shall not bear any liability in such a case.

- Switch off the battery storage system if it is possible without any risk.
- Notify the fire brigade immediately.
- Help others and yourself to get out of the danger area immediately.
- Inform the fire brigade about the presence of Lithium-ion batteries.

**Prevent these hazardous situations. Otherwise, they may lead to deaths or serious injuries.**

---

### **Damaged cells and battery**

Contact the manufacturer.

**Never** operate a potentially or obviously defective battery storage.

---

## **1.2.9 Explosion protection**

---

### **General information**

The battery storage system is de-energised at the time of delivery. Internal connection poles are always live. Therefore, ensure that a tool or a metallic object is not kept in the battery storage system. This could lead to a short-circuit and severe heat formation, which in turn could cause an explosion.

---

### **Explosive atmospheres**

The battery storage system is not suitable for use in explosive atmospheres.

Ensure that there are no ignition sources in the within a radius of 3 m around the system.

---

## **1.2.10 Residual risks**

---

### **General information**

The battery storage system was designed such that no persons are exposed to avoidable hazards. Special danger areas are secured using special safety devices.

Despite this, some danger areas still remain. When working on the battery storage system, you must be aware of these danger areas, the actions to be taken to keep the risk of injuries and material damage minimal.

This operating manual contains safety instructions to indicate these danger areas and essential actions to minimise the risks resulting from such danger areas.

---

## **1.3 Data and safety devices of the battery storage system**

---

### **Safety instructions**

The data and devices for the safety of the battery storage system are specified in this section.

---

### **1.3.1 General hazard instructions and pictograms**

---

#### **Overview**

Adhere to the safety systems and safety instructions described in this operating manual.

Keep the area around the battery storage system free from objects during operation to ensure that unhindered access is always possible.

Pulling the NH isolator disconnects all outside battery poles.

Pay attention to the risk of electric arcs when pulling the isolator under the full load of the battery.

---

#### **Explanation of warning symbols and pictograms**

The following warning symbols have been affixed on the battery storage system to be able to ensure the safety of personnel and the battery storage system:







Symbol	Explanation
	Warning against general hazard sources.
	Warning against electric potential.
	Warning against combustible materials.
	Warning against risks posed by batteries.
	Warning against electric shock.
	Do not dispose with household waste. Please return the battery storage system to the manufacturer.

Figure 1-1: Hazard instructions, pictograms

### 1.3.2 Installed safety systems

#### Overview of safety systems of the battery storage system

Description	Position
NH isolator switch	<ul style="list-style-type: none"> <li>• Connection area: outer housing</li> </ul> 

Figure 1-2: battery storage system, side view of NH1 isolator

The externally accessible fuse elements (NH1) ensure the line protection and short-circuit protection.

### 1.3.3 Safety checks

---

#### General information

The following safety checks were conducted by the manufacturer in the factory.

Description	Position
Test scope	<ul style="list-style-type: none"> <li>• Technical test of the battery management system for flawless scope of functions               <ul style="list-style-type: none"> <li>○ Check whether communication between the battery and the inverter functions.</li> <li>○ Cell voltage test</li> <li>○ Temperature sensor test</li> </ul> </li> <li>• Functional test of the battery at the inverter</li> <li>• Visual inspection of the finished product (outer housing)</li> <li>• Check the complete delivery scope.</li> </ul>

## 2 Function, delivery scope and technical key variables

### 2.1 Function

#### Overview

The BMZ ESS energy storage system stores electric energy in its electro-chemical intermediate storage. This energy can then be retrieved later to compensate the daytime-dependent difference between the power generation and power consumption.

In combination with a suitable inverter, the BMZ ESS system also offers an option of standby power function in case of a mains failure.

Thanks to the modular system, the required storage capacity can be flexibly arranged on the basis of the BMZ ESS system.

### 2.2 Delivery scope

#### Overview of standard delivery scope

The BMZ ESS battery storage system is delivered with the following components:

Description	Quantity
BMZ ESS	1
Quick Guide ESS 7.0   9.0   X Installation with Sunny Island Products	1
Information sheet on off-grid operation	1

Figure 2-1: delivery scope

### 2.3 System overview

#### Battery storage system: Front view

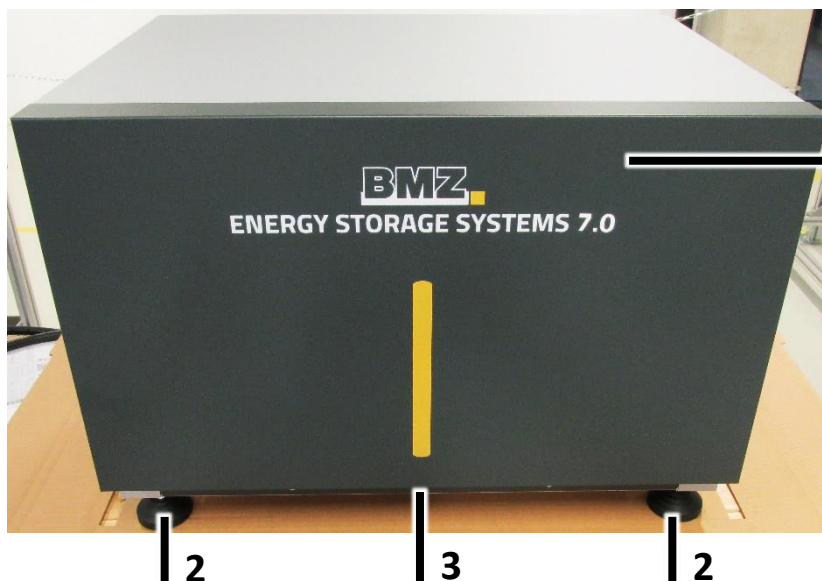

Position	Description
1	Battery housing
2	Supporting feet (adjustable height)
3	Air suction

Figure 2-2: battery storage system, front view

**Battery storage system, side view**

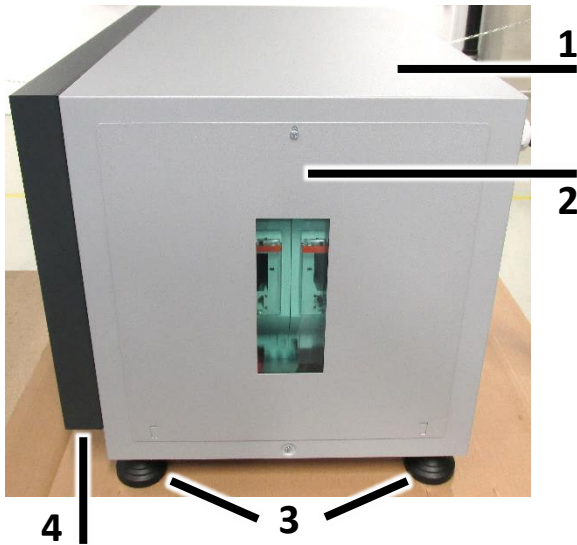

Position	Description
1	Battery housing
2	Removable side wall with an inspection window and NH1 fuses
3	Supporting feet (adjustable height)
4	Air suction

Figure 2-3: battery storage system, side view

**Battery storage system, side view**

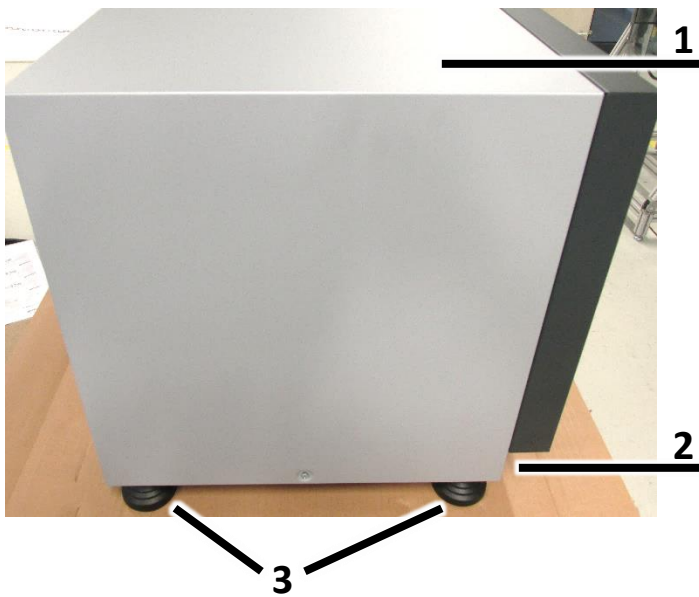

Position	Description
1	Battery housing
2	Air suction
3	Supporting feet (adjustable height)

Figure 2-4: battery storage system, side view



**Battery storage system, rear view**

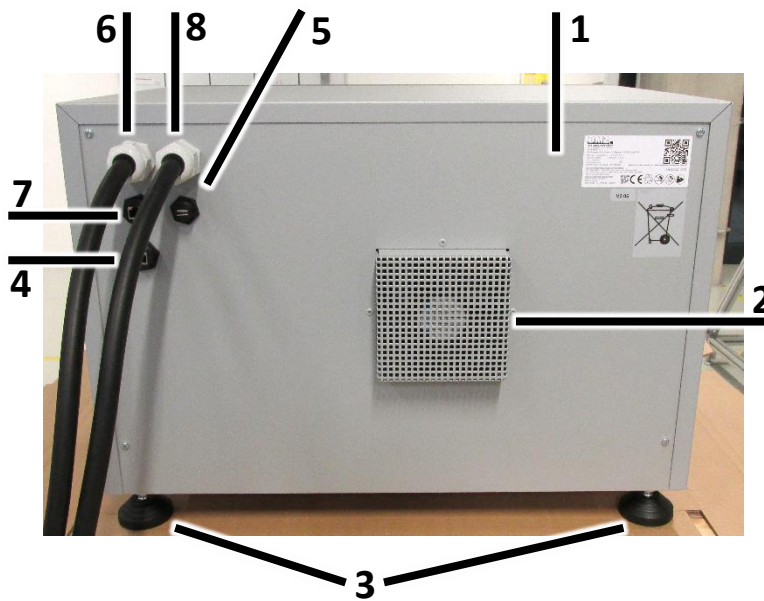

Position	Description
1	Battery housing
2	Air outlet with fan
3	Supporting feet (adjustable height)
4	RS485 bus for multi-parallel mode
5	USB port
6	PLUS line with 50 mm <sup>2</sup>
7	CAN bus for inverter
8	MINUS line with 50 mm <sup>2</sup>

Figure 2-5: battery storage system, rear view

**2.4 Rating plates and warning stickers**

**General information**

The rating plate is provided on the rear side of the battery.



Figure 2-6: battery storage system, rear side

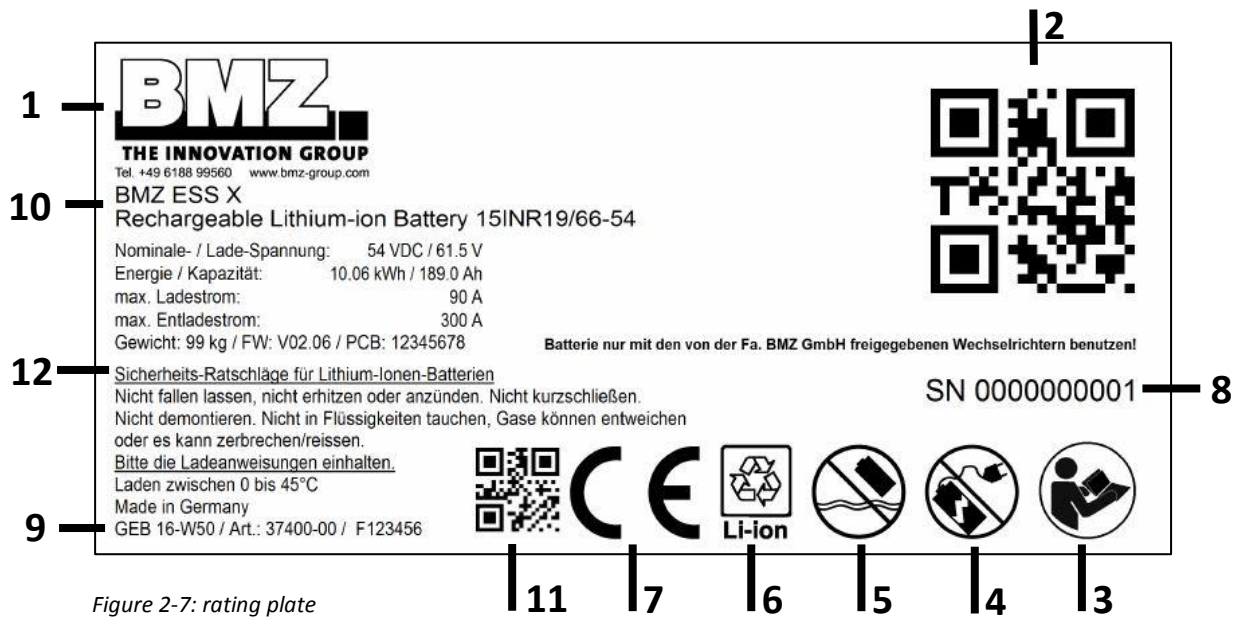

Figure 2-7: rating plate

Position	Description
1	Manufacturer / address
2	QR code (contents: www.bmz-gmbh.de)
3	Safety instruction: Read the operating manual without fail before installation or usage
4	Safety instruction: Do not operate a defective battery
5	Safety instruction: The battery must not become wet.
6	Recycling instruction symbol
7	CE mark
8	Serial number
9	Manufacturing year/month
10	Product name
11	QR code (contents: serial number)
12	Safety instruction: various safety instructions

Figure 2-8: rating plate

### Recycling symbol



Figure 2-10: battery storage system, recycling symbol

### Detailed view

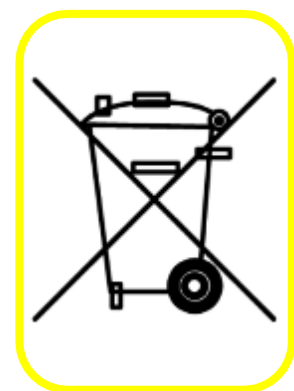

Figure 2-9: recycling symbol

## 2.5 Technical key variables

### Product data

The following table describes the variants of the BMZ ESS system:

Battery storage	Unit	BMZ ESS 7.0	BMZ ESS 9.0	BMZ ESS X
Energy content	kWh	6.743	8.5	10.06
Usable energy content	kWh	5.4	6.8	8.05
Nominal capacity C10	Ah	121.5	156.6	186.3
Nominal voltage	V	55.5	54.0	54.0
Expected calendar-based service life	a	15	15	15
Expected cycle stability		5000	5000	5000
Expected residual capacity at the end of service life	%	80	80	80
Degree of efficiency at 25 °C	%	>95	>95	>95
Cooling		active	active	active
Interfaces		CAN 2.0	CAN 2.0	CAN 2.0
Technology		Lithium Ion NMC	Lithium Ion NCA	Lithium Ion NCA
Self discharge rate per month	%	1-3	1-3	1-3
Dimensions H/W/D	cm	approx. 46 x 64 x 48	approx. 46 x 64 x 48	approx. 46 x 64 x 48
Weight	kg	95	97	99
Certifications		UN 38.3; CE	UN 38.3; CE	UN 38.3; CE

Figure 2-11: overview of technical specifications

## 3 Transport

### 3.1 Safety instructions for transport

---

#### Target group

Safety instructions intended for the installation personnel who transport, install and put the BMZ ESS battery storage system in operation.

---

#### Safety instructions

For transporting the battery storage system and when working on electrical devices, please follow the safety instructions from the Safety section, page 10.

### 3.2 Transporting the battery storage system

---

#### Delivery of the battery storage system

##### Delivery

The battery storage system is packed in a mechanically robust, three-walled corrugated paper carton and delivered.

##### Incoming inspection

Check for the completeness using the delivery note.

##### Damage

Check the delivery for damage.

Visual inspection: e.g. damaged packing, scratches, dents, paint damage, missing components

##### If the delivery has been damaged during transport:

- Ask the forwarding agent to acknowledge obvious transport damage in writing and on the site.
  - Contact the last forwarding agent immediately.
  - Store the packing (for a possible inspection by the forwarding agent or for returning the product).
  - Take photos for easier documentation.
  - Write a short fault report.
  - Never install or operate a potentially or obviously defective battery storage.
- 

#### Check the goods at the time of acceptance

Before accepting the goods, check whether the shipment is complete and flawless. The operating manual contains an exact list of all components.

Before accepting the goods, check whether the carton is broken, deformed or destroyed. In such case, refuse the acceptance or accept only with conditions and a written confirmation of the forwarding agent.

Immediately check whether the test seal in the battery is intact. The inner housing of the battery has 3 test seals. If one test seal is destroyed, refuse to accept the goods.

 **If a test seal is destroyed, all guarantee and warranty claims for the product shall be void.**

 **If the test seal is destroyed: Do not install or commission the energy storage system under any circumstance.**

**Rear side of the battery inner housing**



Figure 3-1: seal position

**Front side of the battery inner housing**



Figure 3-2: seal position

**Contents of the seal:**

- Version 1: Warranty is VOID if this seal is broken (black seal)
- Version 2: Warranty VOID if removed (silver seal)

**Packing for return shipment**

- If possible, use the original packing and the original packing material.  
If both are no longer available, request a packing company with experts or contact the manufacturer.
- Place the transport units on a pallet (it must be designed depending on the weight).
- Use the original packing material to protect the housing from scratches and transport damage.

If you have queries regarding packing and transport safeguarding, please consult the battery manufacturer.

Contact	BMZ USA	BMZ Germany
Phone:	+1 757 821 8494	+49 (0) 6188 9956 9830
Email	Service.USA@bmz-group.com	CS.BigPack@bmz-group.com

**Intermediate storage**

Start using the battery within six months after delivery.

**Storage conditions:**

- Closed and dry room with a room temperature from +10 °C to +30 °C (temperatures below and above this range shorten the service life)
- Relative air humidity must be a maximum of 80% (non-condensing).

- The spatial distance from walls or other objects must be at least 50 cm.
- The battery storage system must be stored only in an upright position.
- 👉 Never clean the battery storage system or its immediate vicinity using a vapour jet or spray water. Dirt and water may enter the battery storage system and cause major damage.
- 👉 Before storing the lithium ion battery, inform your insurer.

**After a storage time of a maximum of 6 months, execute an equalisation charge process for the battery as described in the operating manual of the battery inverter.**

- **If this is not done, batteries may get damaged.**
- **If this is not done, it will lead to consequential costs which will not be borne by BMZ.**

The entire time of storage of batteries must be included in the usage duration.

### Transport to the installation site (of the customer)

- Only the experts may carry out the transport in accordance with local conditions.
- The commercial installer is authorised to transport an energy storage unit without the ADR note for the transport of hazardous goods.
- The free limit for such “transport of hazardous goods” is 333 kg or 999 points (net weight of the hazardous product x 3 = points /ADR regulation). According to ADR, the identification of the vehicle is essential from 1000 points onwards and the driver must have an ADR note.
- Every transport must be provided with an accompanying document (transport document as per ADR hazardous goods UN3480) irrespective of the points.

The transport units are transported on pallets and exclusively in original packages up to the customer’s installation site. The product must be installed out of the reach of children and animals.

⚠ **WARNING**



**Risk of injuries due to improper transport.**

Pay attention to the weight of the transport unit when transporting (see technical specifications).

- The transport unit may tilt during transport. Pay attention to the centre of gravity.
- If necessary, secure the transport unit using suitable lifting tackles before transporting.

**Prevent these hazardous situations. Otherwise, they may lead to deaths or serious injuries.**

### Transport with a sack truck



**The sack truck must be designed for the weight of transport units.**

Step	Description
1	Place the energy storage unit, with the contact with the rear wall, on the sack truck.

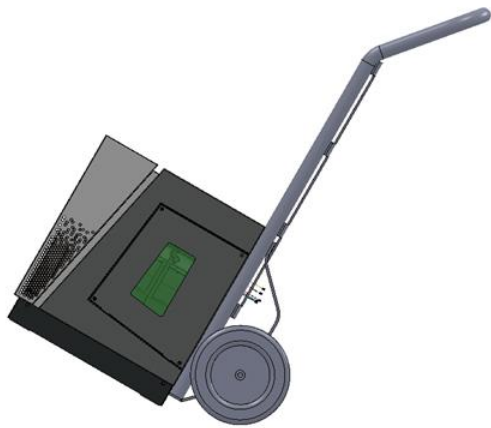

*Figure 3-3: transporting with the sack truck*



Use a soft protective cloth to protect the energy storage unit from scratches.



In case of steps, only use the specially designed step sack trucks.

2

Secure the energy storage unit with tightening straps on sack trucks.



## 4 Installation, assembly and commissioning for the first time

### General information

Only the experts trained by BMZ GmbH may carry out the installation, assembly and first commissioning activities.

### 4.1 Installation site requirements

#### Installation site

The BMZ ESS battery storage system is only intended for usage in buildings. Usage of the battery only in non-living space. The battery housing has been designed for a stack of up to 3 battery storage systems. Use the structural analysis of the building to check whether it is designed for the load of the system. Each energy storage unit weighs approximately 99 kg. If three energy storage units are stacked on each other, intermittent loads of a maximum of 297 kg act on the floor.

The installation site must fulfil the following requirements:

- Levelled (e. g.: maximum setting range of adjusting feet)
- Dry (maximum air humidity 80%, non-condensing)
- Clean (well-swept, dust free)
- Vibration-free (maximum shock 0.5 g)
- No direct solar radiation
- No naked flames or other ignition sources near the installation place (minimum distance 3 m)
- Adequate distance (at least 20 cm) between the battery storage system and walls
- Adequate air circulation to dissipate the heat generated by the battery storage system.
- A maximum of three batteries can be stacked to tower.
- Installation site below 2000-metre altitude.

#### TOPVIEW

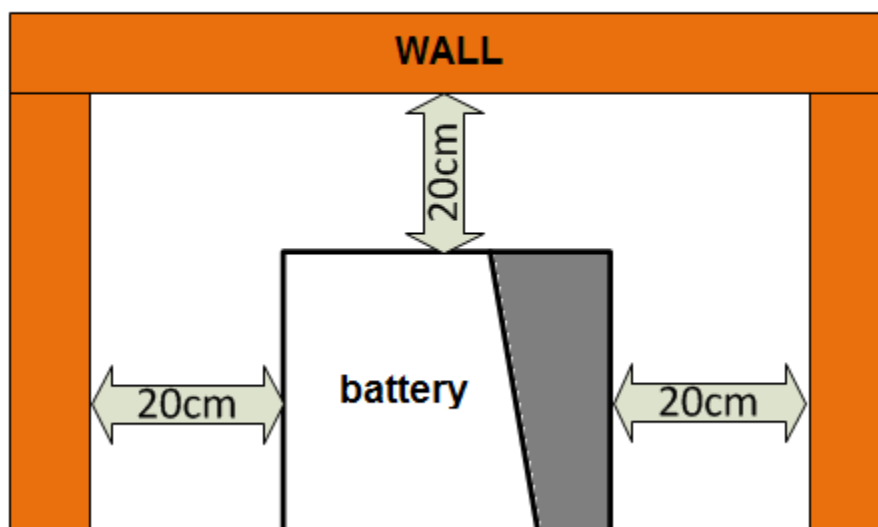

Figure 4-1 : Requirements for the installation site, distance of the ESS from walls, top view



## SIDE VIEW

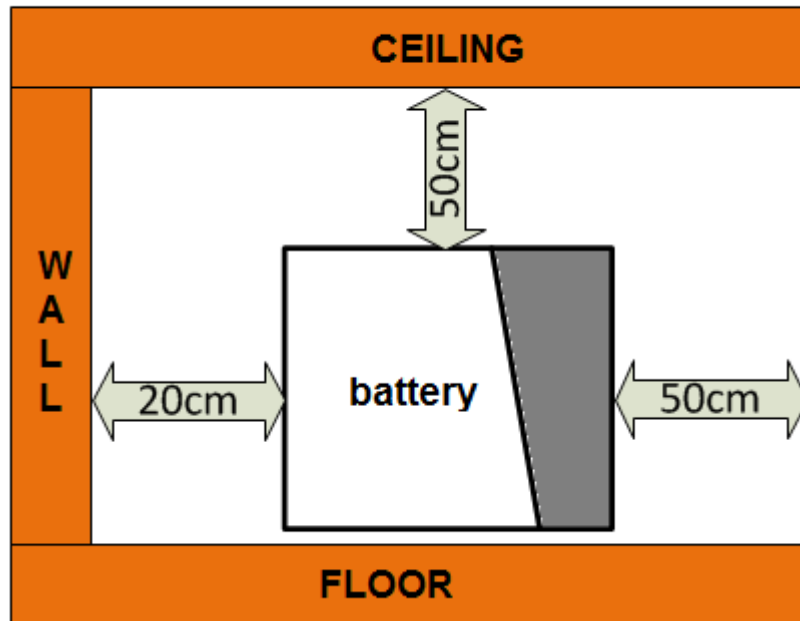



Figure 4-2 : Requirements for the installation site, distance of the ESS from walls, side view



The room air must not contain contaminations like suspended particles, metal dust or combustible gases. Ensure that the air humidity does not exceed 80%.

The room temperature should be in a range from 0 °C to 25 °C, wherein 15-20 °C are optimum for a long service life.

-  Operate the battery storage system only in the upright position.
-  Ensure that the service flap at the side (NH1 fuses) is always freely accessible.

Install the battery inverter and the battery storage system near each other. Do not lay the connecting cable between the battery and the inverter in windings. The maximum length of this cable is 2.3 m.

Only use the provided original cable.

-  **Do not shorten the cable arbitrarily.**
-  **Do not extend the cable arbitrarily.**
-  **Do not lay the cable in loops.**

### Immediate surroundings of the battery storage system

The immediate surroundings of batteries must be clean and dry. Oil contaminations, dirt or water residues must not be found outside the battery. If contaminations are found, remove them immediately. Additional information regarding this is given in: *VDE 0510 Part 2: 2001-12, EN 50272-2: 2001 "Safety requirements for batteries and battery systems – part 2: stationary batteries"*.







## 4.2 Filling the installation check list

The installer must fill the installation check list carefully; it shall be valid only with a signature and the company stamp. Store the completed installation check list carefully. In the annexe you will find a form of the installation check list. Warranty and guarantee claims against the manufacturer can only be made if the completed installation check list is submitted together with the warranty card and the original proof of purchase.

## 4.3 Installation of the battery storage system

### Installation steps

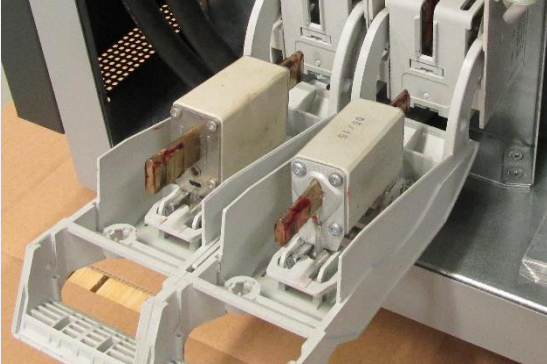
Proceed as follows to install the battery storage system:

Step	Description
1	<p>Unpack the battery storage system carefully and check it for transport damage. In case of transport damage, contact the forwarding agent or the manufacturer immediately.</p> <p> Do not use a knife to open the packing.</p> <p> <b>Never</b> install and operate a defective energy storage unit</p>
2	Check whether all structural parts and accessories exist.
3	<p>Check whether the battery storage system has been switched off.</p> <p> Both LEDs must not light up.</p> <p> Use a voltmeter to measure the DC voltage.</p>
4	Bring the battery storage system on the pallet to the installation place using suitable transport aids.
5	<p>Check whether the current isolator (NH isolator) is pulled.</p>  <p><i>Figure 4-3: representation of the pulled current isolator</i></p> <p> The current isolator must be pulled before installation.</p>
6	<b>Use a suitable lifting device to lift the battery storage system from the pallet (e.g. workshop crane).</b>
7	<p>Position the battery storage system on the installation site.</p> <p> Adhere to the minimum distances from walls. (See section 4.1 Requirements for the installation site)</p>

## 4.4 Preparing the electrical connections for the single mode

### Definition of single mode

Single mode means the operation of **one** BMZ ESS energy storage system with **one** inverter.

### Safety instructions

Please follow the safety instructions in the Safety section, page 10.

### Establish the connections between the inverter and the battery



Pre-conditions:







- The current isolator (NH isolator) must be pulled
- The battery inverter must be switched off ("Off")

Check for the correct polarity carefully before establishing connections. Connection lines are marked in different colours:

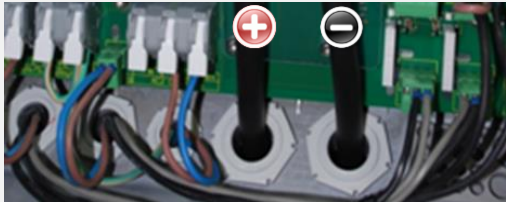
- **Plus pole = RED**
- **Minus pole = BLACK**

The connection of a battery with an SMA Sunny Island inverter is described below as an example.

-  When using another inverter, please follow the specifications in the corresponding manufacturer's documentation.
-  Check whether the inverter used by you is approved for use with the BMZ ESS battery storage system.

Step	Description
1	<p>Push the 50 mm<sup>2</sup> lines through metric screw joints into the housing of the inverter.  <b>Plus pole = RED</b>                      Minus pole = BLACK</p>  <p><i>Figure 4-4: inverter, connection area for battery lines</i></p> <ul style="list-style-type: none"> <li> The 50 mm<sup>2</sup> connection lines must <b>NOT</b> be connected to incorrect poles.</li> <li> Follow the installation manual of the inverter manufacturer.</li> </ul>
2	<p>Connect the power cable of the battery inverter to the poles of the NT isolator.                      Use the 2 screws of the M8x20 size as well as washers and tension washers.</p>  <p><i>Figure 4-5: sample representation of the connection of plus and minus power cables with the SMA Sunny Island inverter</i></p> <ul style="list-style-type: none"> <li> Ensure that the contact surface of cable shoes rests completely.</li> <li> Maximum tightening torque: 12 Nm. (Tolerance +/- 5 Nm)</li> </ul>

- 3 Connect the CAN communication cable between the inverter and the battery storage system.  
For this purpose, patch the patch cable (RJ45) from the **CAN socket** of the battery storage system to the **CAN socket** of the inverter. (Marked in yellow)

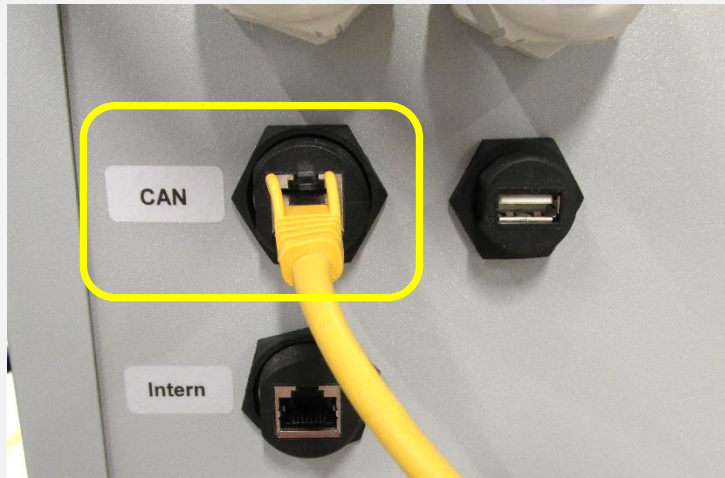

Figure 4-6: representation of external connections of the battery system, CAN

- 4 Insert the NH fuses in the cover of the NH isolator.



Figure 4-7: battery storage system, side view of the opened housing



Change the fuse inserts depending on the inverter to which the battery is connected.

Recommendation:

SI3.0M-11:	80 A
SI4.4M-11:	100 A
SI6.0H-11:	160 A
SI8.0H-11:	200 A

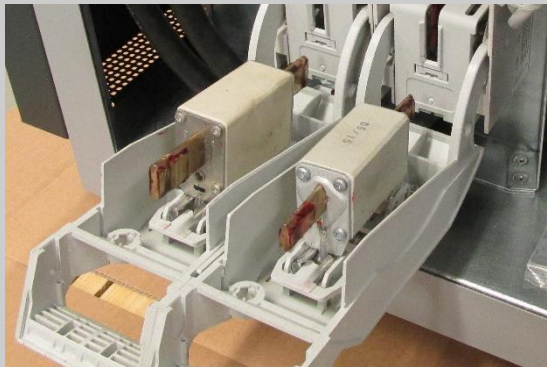

Figure 4-8: representation of the correctly inserted fuses

- 5 Insert the housing cover in the housing and tighten the screws of the cover.  
For this purpose, use one DIN 7985 M4x6 fillister-head screws. Fix these using a PH2 Phillips screwdriver and a maximum tightening torque of 2.5 Nm (tolerance: +/-0.1 Nm).

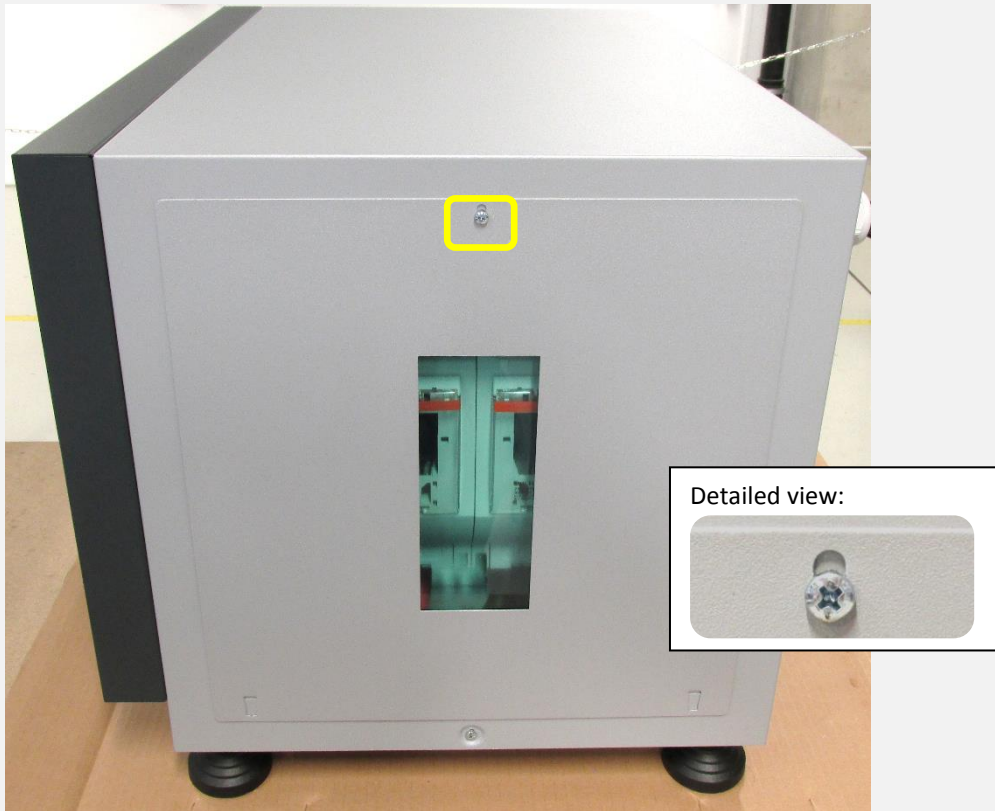



Figure 4-9: battery storage system, side view

-  The cover may remain open during the first installation in order to switch on the battery. Close the cover after switching on the battery

- 6 Execute the first commissioning process by following the specifications from the Operation section (page 70).

- 7 Configure the parameters of the inverter as mentioned in section 4.17 (Recommended parameters).

-  Ensure that the batteries are not earthed by mistake. If they are earthed, disconnect the corresponding connection.

-  Check all parts for firm fitting. Re-tighten all screws and terminals.

#### 4.4.1 Checking the connections

Check the connections as per the exact specifications in the installation check list given in the annexe.





#### 4.4.2 Switching the battery storage system on and off

The battery storage system and the inverter must be correctly installed before they can be put into operation.

#### Switch on the battery storage system using a switch

Proceed as follows to start the battery storage system:



Step	Description
1	Open the screws on the service flat using a PH2 screwdriver.
2	Check whether the NH isolator is equipped with correct (see section 4.5) NH fuses and put into operation correctly.
3	Check the connections of the DC power cable (+, -) and the CAN communication cable of the battery inverter.
4	<p>Actuate the push button through a short (longer than 1 second) push.</p>  <p> A clicking sound must be heard.</p>
5	<p>Check the LED status of the battery storage system.</p> <ul style="list-style-type: none"> <li>The green LED flashes quickly (every 100 msec): The pre-charging path is activated and charges the capacitors of the inverter. (The pre-charging time depends on the type and number of connected inverters. The pre-charging time can take from 30 seconds to 2 minutes)</li> <li>Both LEDs flashes slowly (every 1 second): The battery is active and waits for communication through the inverter.</li> </ul> <p> The battery switches off automatically after 20 minutes if there is no communication between the battery and the inverter.</p> <p> Additional information regarding the LED flashing patterns is given in the Pilot lamps section, page 71.</p>
6	<p>Switch on the battery inverter.</p> <ul style="list-style-type: none"> <li>The green LED lights up continuously</li> </ul> <p> If there is no communication between the battery storage system and the inverter, the battery switches off automatically after 20 minutes to avoid erroneous operating modes. Both LEDs flash in a one-second cycle if there is no communication.</p>



### Switch on the battery storage system using an external voltage source

Proceed as follows to start the battery storage system:

Step	Description
1	The external voltage source can be used to switch on the system only if it was not switched off using the push button (press the push button longer than 10 seconds at a stretch).
2	Connect an external voltage source greater than 36 VDC.
3	The battery detects the external voltage source automatically and switches the operating mode from inactive to active.
4	<p>If it is switched on in an unauthorised manner, the green LED flashes quickly (100 ms flash cycle)</p> <p>You must now start the battery using a normal switch-on sequence (by pressing the push button longer than 1 second).</p>

### Switch off the battery storage system using a push button

Proceed as follows to switch off the battery storage system:

Step	Description
1	Open the screws on the service flat using a PH2 screwdriver.
2	Keep the switch-on button pressed for at least 10 seconds. 
3	After approximately 8 seconds, both LEDs start flashing quickly (100 ms flash cycle).  Keep the button pressed for 2 more seconds.
4	The LEDs switch off. The battery storage system is now switched off.  A clicking sound must be heard.

### Switch off the battery storage system using time

The battery switches off automatically after a defined time of 20 minutes when the battery does not detect any CAN communication externally.

Step	Description
1	If an external source (e.g. the battery inverter) does not detect a CAN communication of the battery, the battery switches off automatically after 20 minutes.

### 4.4.3 Configuring the parameters of the inverter

The inverter parameters must be configured for the BMZ ESS battery in order to operate it optimally in combination with the inverter.

See section 4.18

## 4.5 Preparing the electrical connections for the parallel mode

### Definition of parallel mode:

Parallel mode means the operation of **multiple** BMZ ESS energy storage systems at **one or more** inverters.

### Safety instructions

Please follow the safety instructions in the Safety section, page 10.

**The following safety instructions are additionally applicable for the parallel operation:**

- If the battery is operated under full load, housing parts and lines may generate heat.
- When wiring the batteries, ensure that a short-circuit is never formed between the plus and minus poles of one or more batteries. There is a risk of life.
- When laying the lines, do not extend them from the plus and minus poles.
- When laying the lines (plus and minus poles), ensure that they are not rolled.

### Establish the connections between the inverter and the battery

Pre-conditions:

- The current isolator (NH isolator) of each battery must be pulled
- The battery inverter must be switched off ("Off")
- Use a suitable switch cabinet to connect the batteries in the parallel circuit to the inverters.  
BMZ recommends using a DC busbar with a suitable line fuse for each connected line.



BMZ recommends using products of SMA (Bat fuse) or Enwitec (BAT BREAKER BOX)

Check for the correct polarity carefully before establishing connections. Connection lines are marked in different colours:

- **Plus pole = RED**
- **Minus pole = BLACK**

---

### Prerequisites for the battery firmware version



Batteries can be connected in parallel from firmware version V2.00 onwards.



The BMZ Service Tool in a specific version (at least Version 0.0.26) must be used to update the battery to a new firmware version.

---

### Requirements for the battery inverter



The parallel connection capability of BMZ ESS batteries is approved only with the battery inverters of SMA Sunny Island.



Check whether the inverter used by you is approved for use with the BMZ ESS battery storage system.

## 4.6 Connection concept of multiple BMZ ESS batteries with one or more battery inverters

### 4.6.1 Communication

---

#### Wiring of the communication line from the battery to the inverter

- Connect the CAN cable to the battery that has been configured as the master and connected with the inverter.

---

#### Wiring of the communication line from between the batteries (internal communication of battery)

- All batteries in the parallel circuit are connected with each other via the RS485 bus for internal communication between them. The batteries are connected in a bus topology. For this purpose, T-connectors (or even Y-adapters) are used at the RJ45 sockets ("INTERNAL" label) of batteries.
- One T-connector (or even a Y-adapter) is used for each battery.

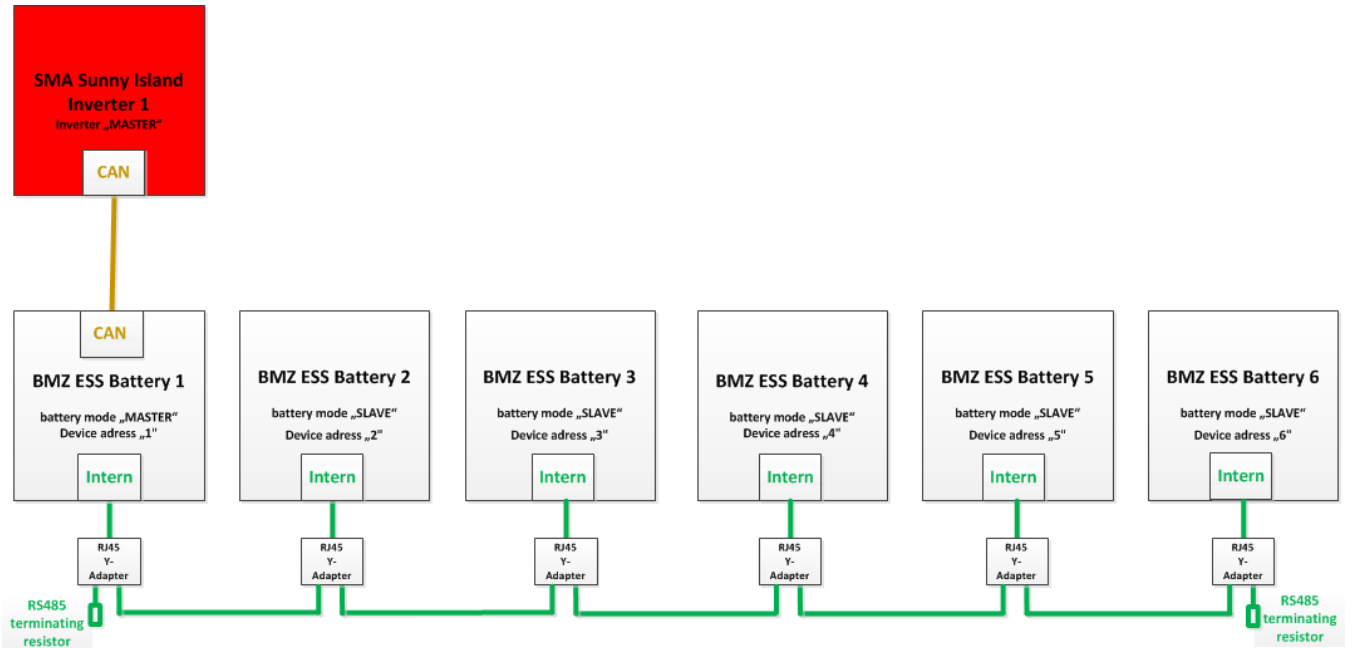

Figure 4-10: communication cabling, ESS parallel connection

- The RS485 bus must be closed with 120 Ohm at both ends

Example of a RJ45 T-connector (or even a Y-adapter) with corresponding pin assignment



Figure 4-11: RJ45 Y-adapter (even RJ45 T-connector)

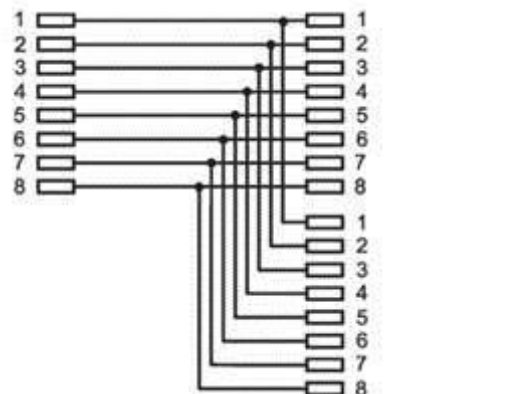



Figure 4-12: pin assignment of RJ45 Y-adapter (T-connector)

## 4.6.2 Contacting power cables

### Safety

<b>ATTENTION</b>	
	<p><b>Risk of battery damage</b></p> <p>When switching on the battery, a wrong connection can cause a short circuit which destroys the battery fuse.</p> <p>When wiring the Bat Breaker Box (output rail):</p> <ul style="list-style-type: none"> <li>• Connect <b>Pack PLUS</b> only to <b>Pack PLUS</b> potentials.</li> <li>• Connect <b>Pack MINUS</b> only to <b>Pack MINUS</b> potentials.</li> </ul>

### Important:

When interconnecting the output contacts, all fuses (NH1 isolators) of individual batteries and the switch cabinet are **removed**, and the **automats** in the BAT BREAKER Box are set to **OFF**.



Figure 4-13: battery storage system, side view, power isolator pulled

### Important:

Please refer to the installation manual „Batterie-Absicherung ‚BAT BREAKER‘ Typ ...“ by the company enwitec electronic for additional instructions regarding installation and operation.

### Laying the power cables

- The power cable should be as short as possible.
- The length of the Pack+ and Pack- cables must not exceed the respective maximum lengths.
- Cables of each battery (plus and minus poles) must always have the equal length.
- Cables of a battery connected in a parallel circuit must have the equal length between the batteries.

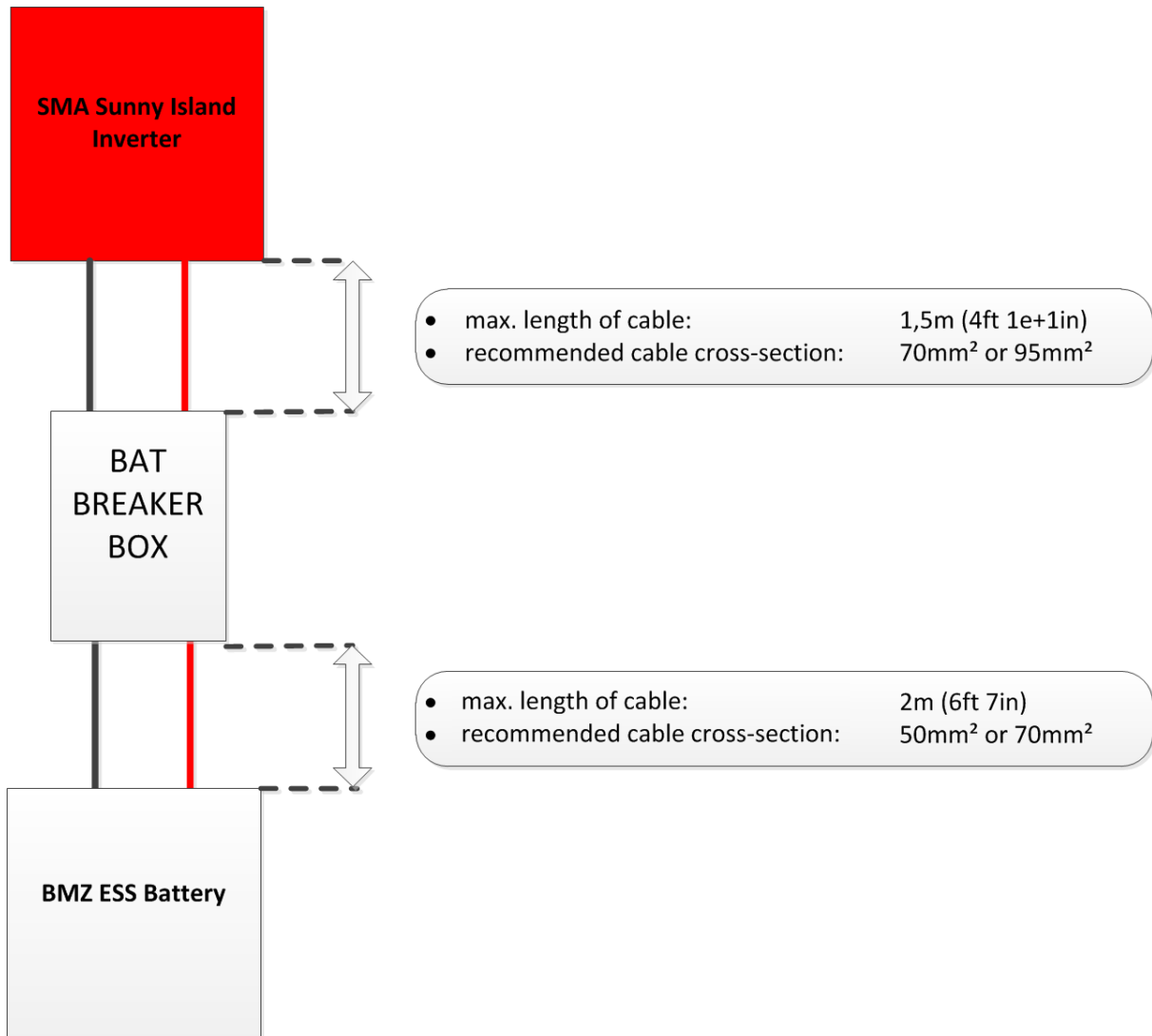

Figure 4-14: cable lengths of the ESS system

### Connecting the power cables

- All plus poles of batteries must be connected to a copper rail using the Bat Breaker Box.
- All minus poles of batteries must be laid on a copper rail using the Bat Breaker Box.

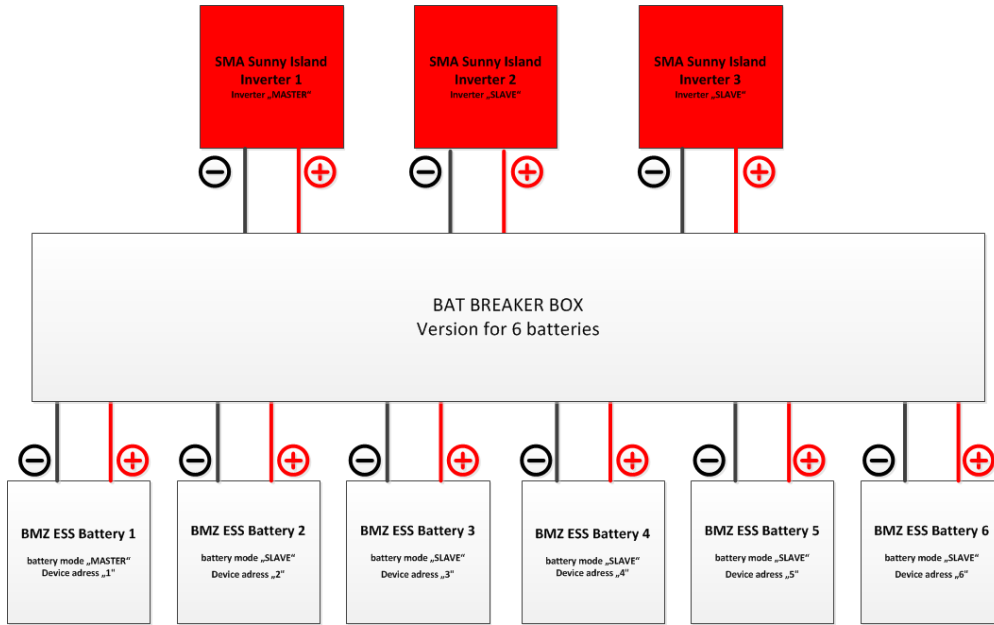

Figure 4-15: output cable of BAT Breaker Box

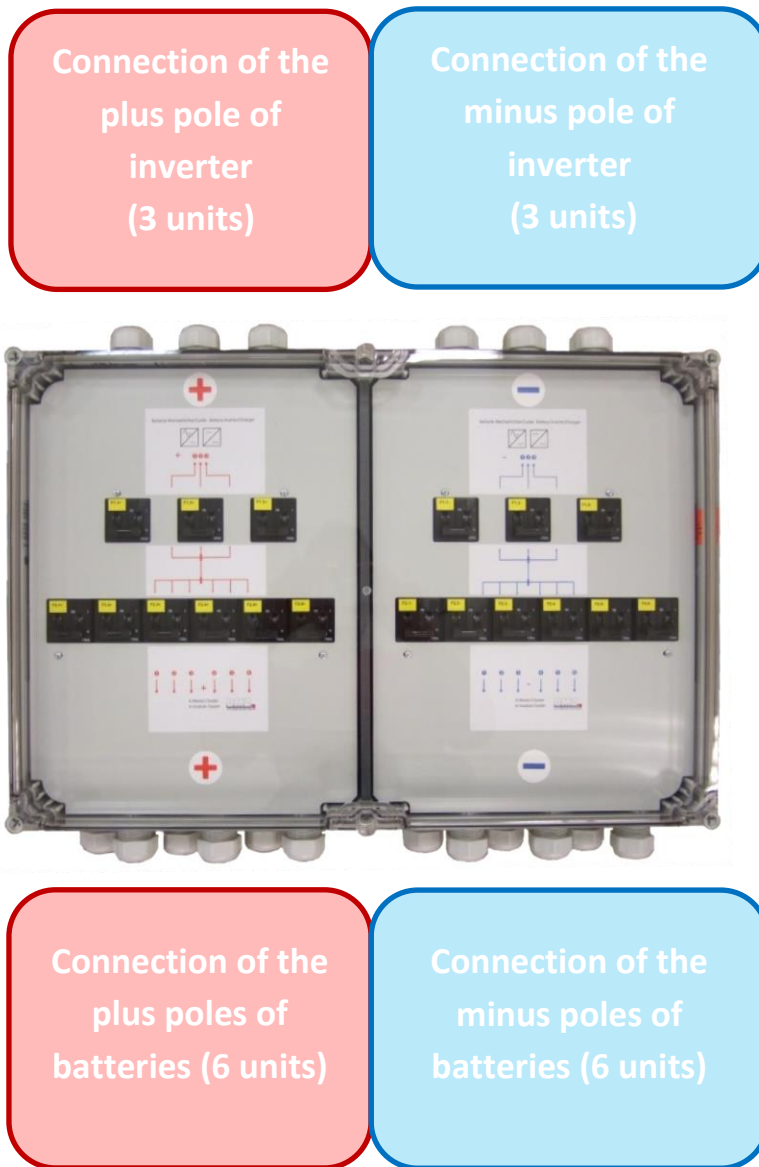

Figure 4-16: BAT BREAKER Box of Enwitec (example for 6 batteries and 3 inverters) with a closed housing

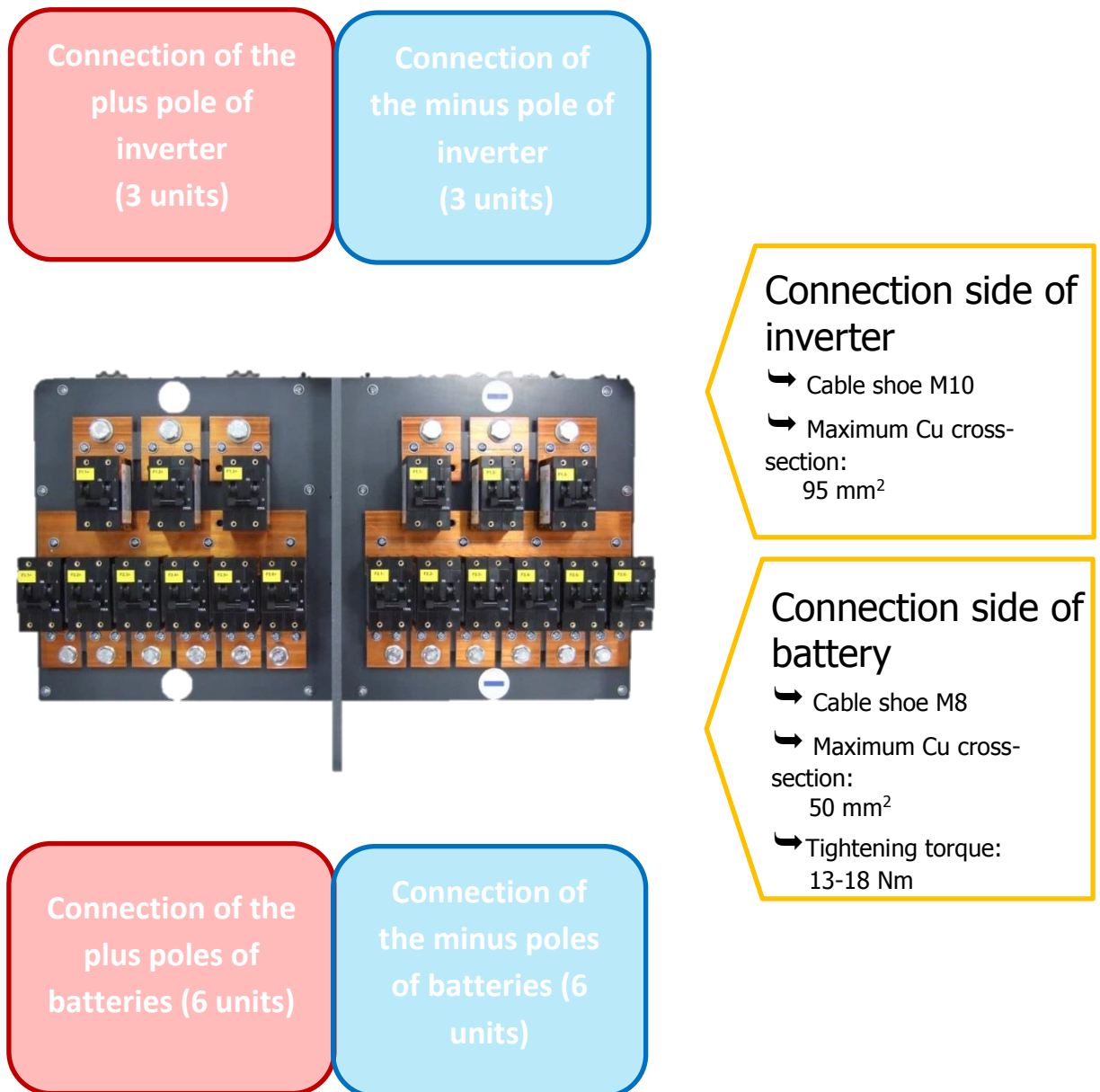

Figure 4-17: BAT BREAKER Box of Enwitec (example for 6 batteries and 3 inverters) with an open housing

## 4.7 Configuration of the ESS parallel mode

Thanks to the modular concept of the BMZ ESS system, different configurations of BMZ ESS batteries with SMA Sunny Island inverters are possible.

### 4.7.1 1-phase operation of a SMA Sunny Island inverter on 1 ESS battery

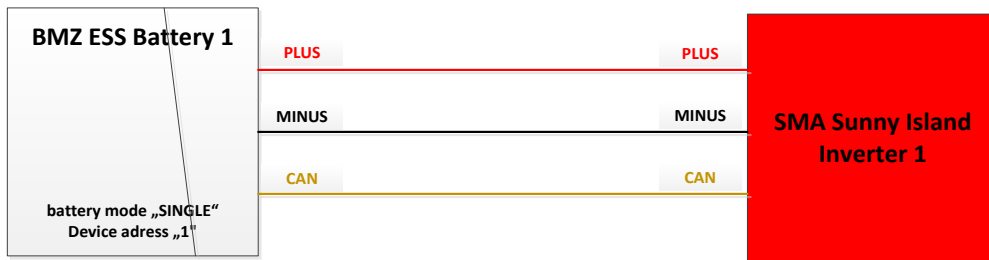

Figure 4-18 : 1-phase operation on 1 ESS battery

### 4.7.2 1-phase operation of a SMA Sunny Island inverter on 2 ESS batteries

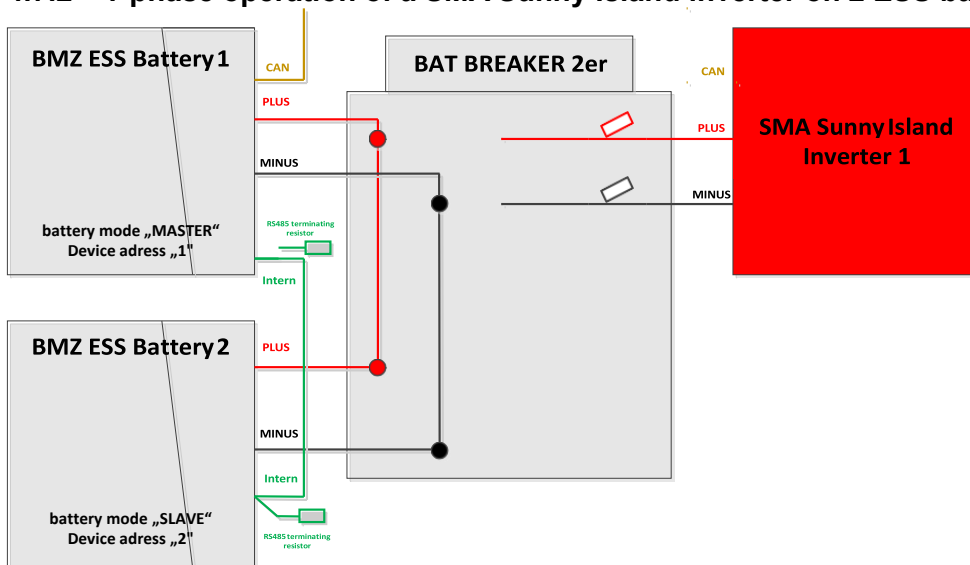

Figure 4-19: 1-phase operation on 2 ESS batteries



### 4.7.3 1-phase operation of a SMA Sunny Island inverter on 3 ESS batteries

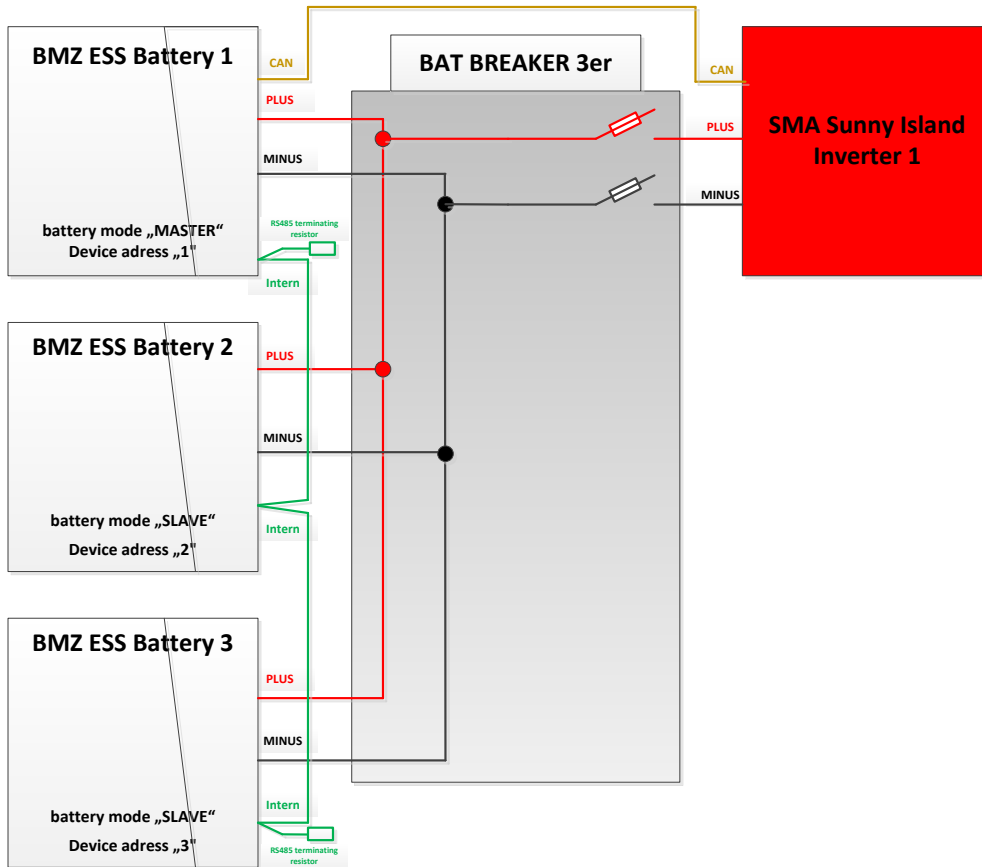

Figure 4-20: 1-phase operation on 3 ESS batteries

#### 4.7.4 3-phase operation of a SMA Sunny Island inverter on 3 ESS batteries

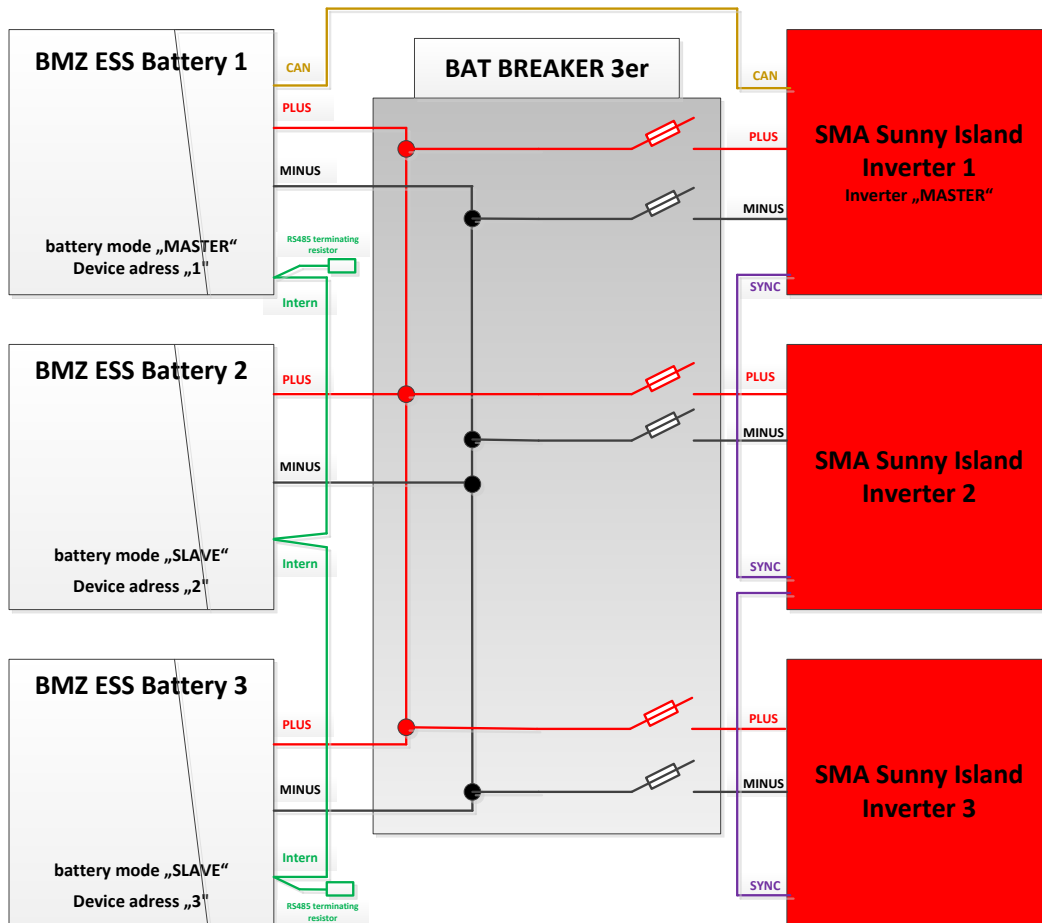

Figure 4-21: 3-phase operation on 3 ESS batteries

### 4.7.5 3-phase operation of a SMA Sunny Island inverter on 4 ESS batteries

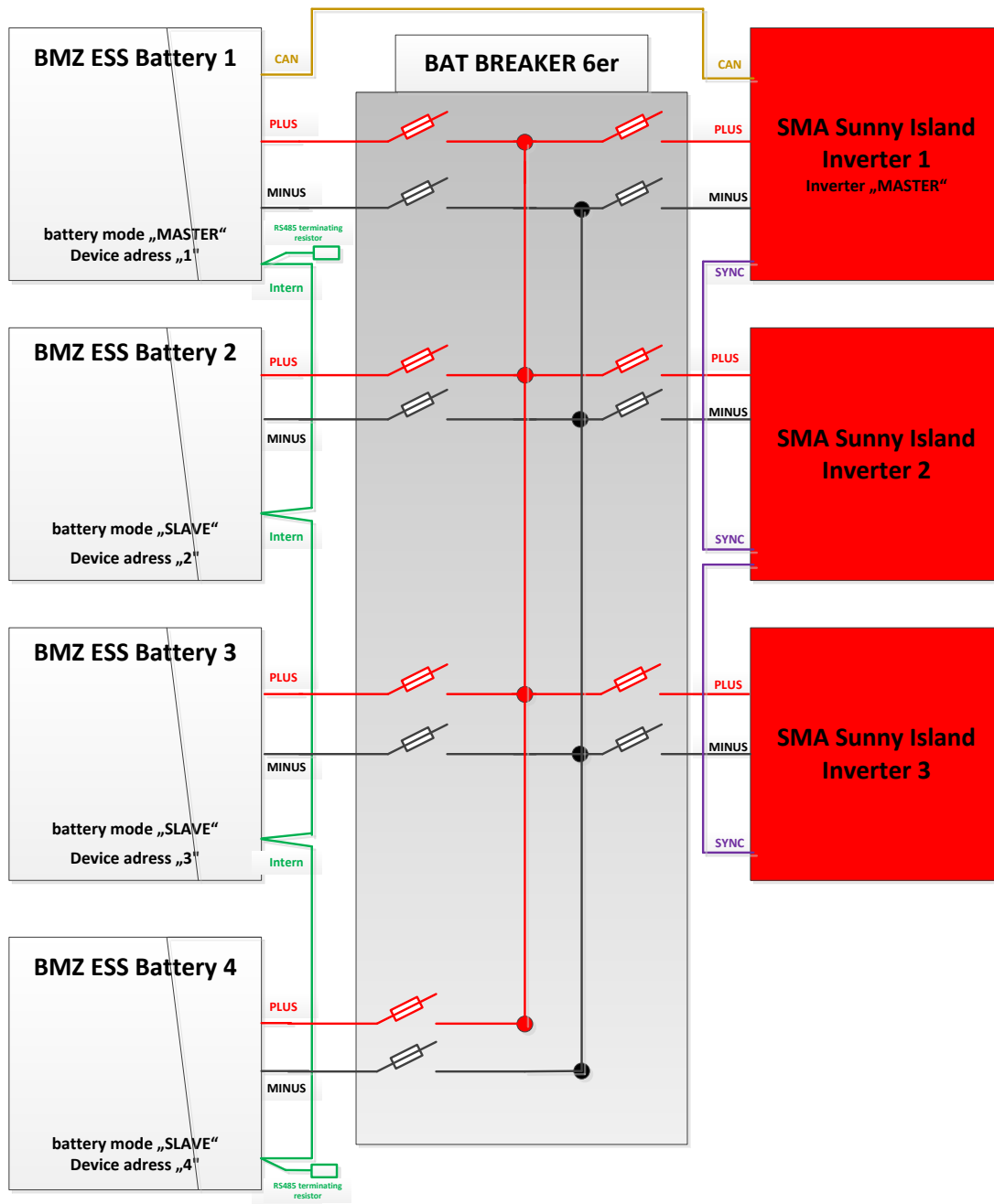

Figure 4-22: 3-phase operation on 4 ESS batteries

### 4.7.6 3-phase operation of a SMA Sunny Island inverter on 5 ESS batteries

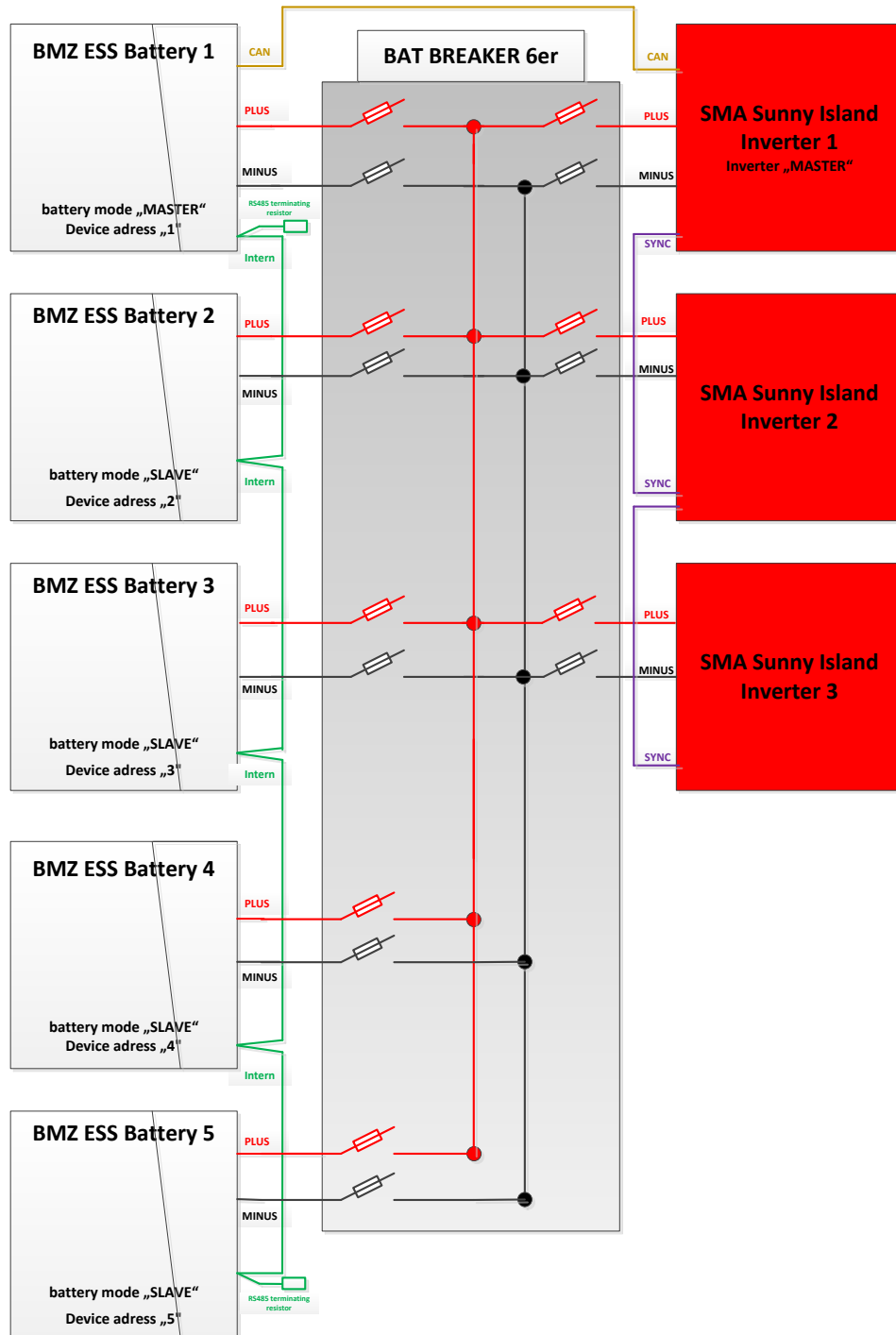

Figure 4-23: 3-phase operation on 5 ESS batteries

### 4.7.7 3-phase operation of a SMA Sunny Island inverter on 6 ESS batteries

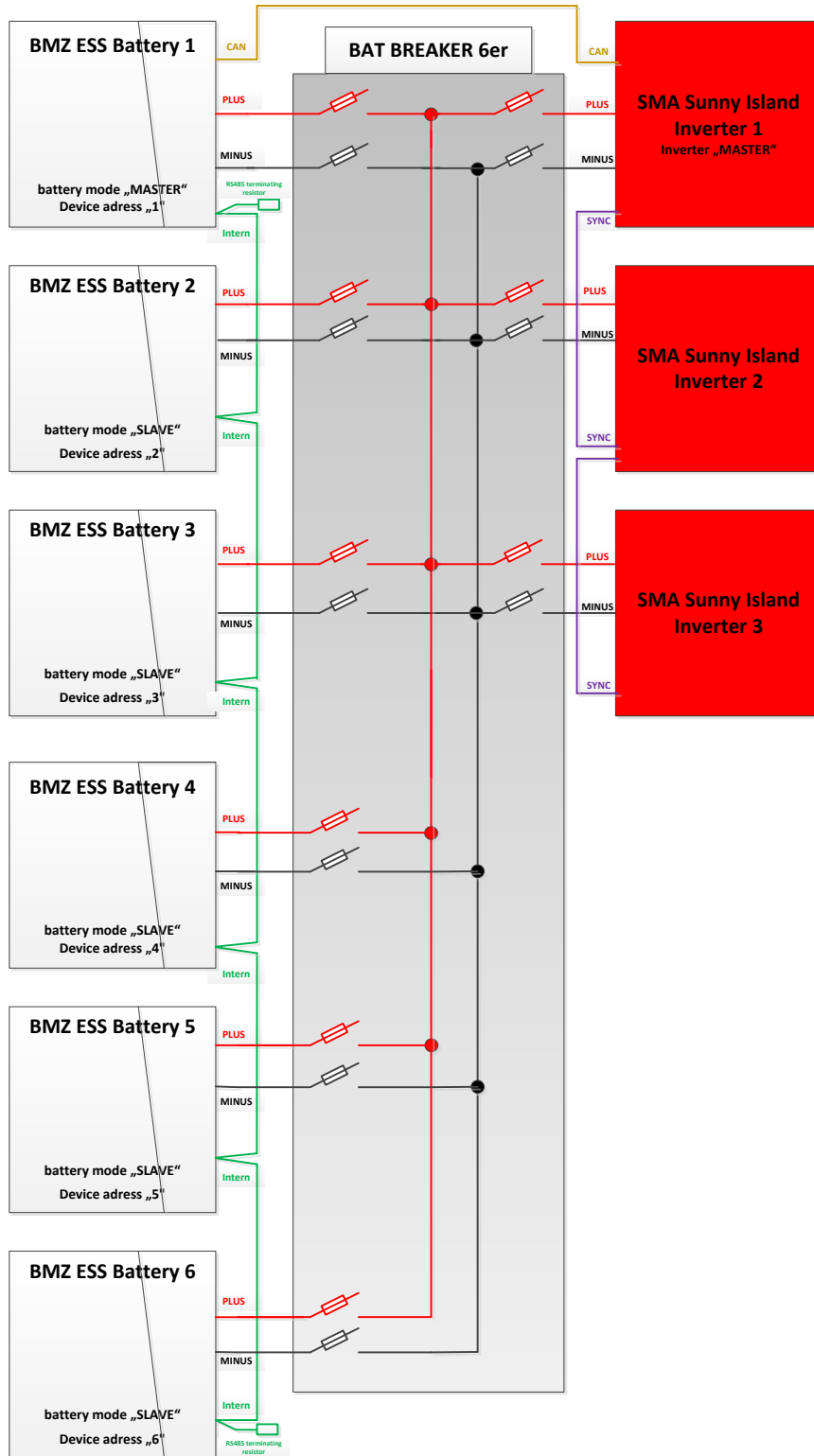

Figure 4-24: 3-phase operation on 6 ESS batteries

### 4.7.8 3-phase operation of a SMA Sunny Island inverter on 9 ESS batteries

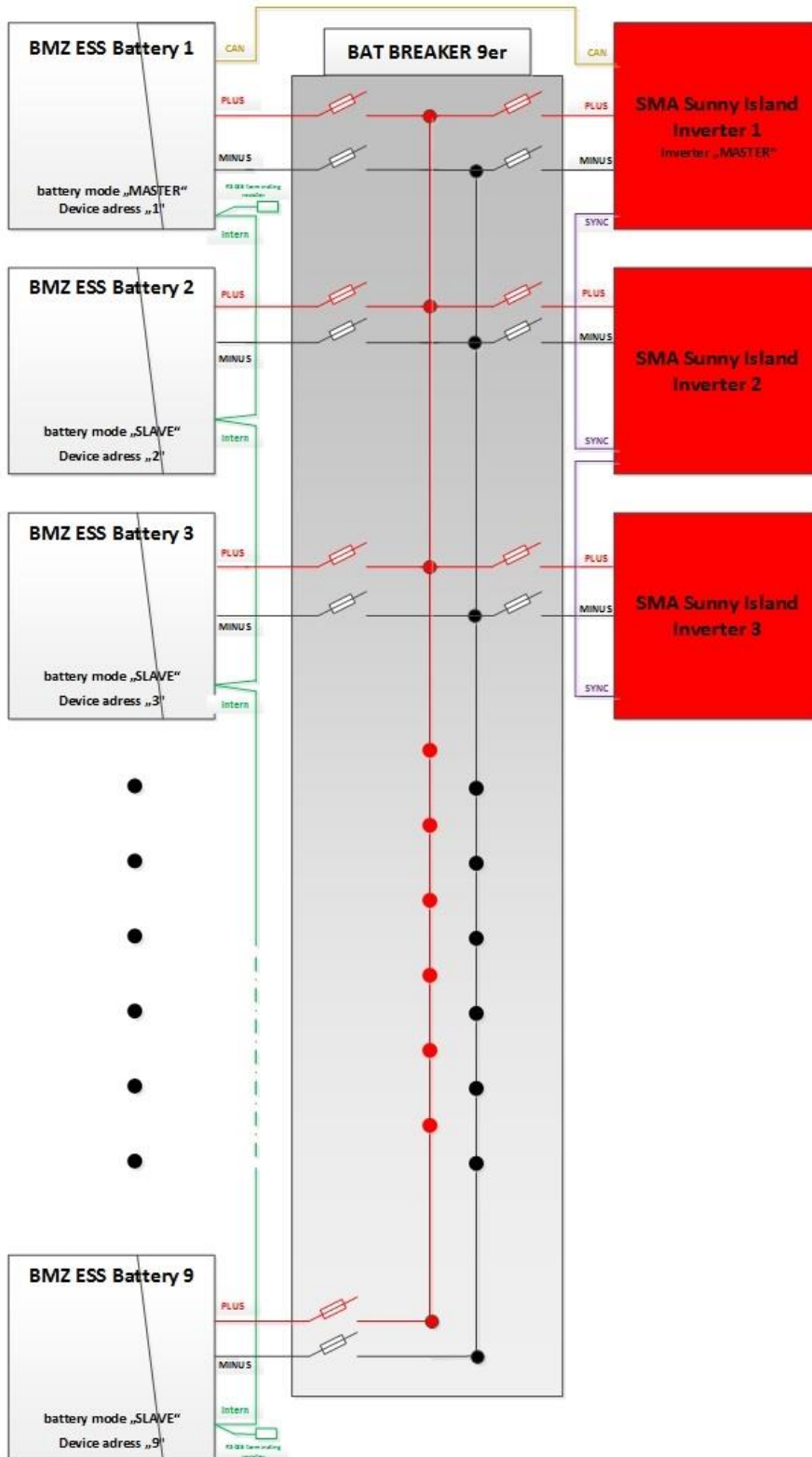

Figure 4-25: 3-phase operation on 9 ESS batteries

### 4.7.9 3-phase operation of a SMA Sunny Island inverter on 12 ESS batteries

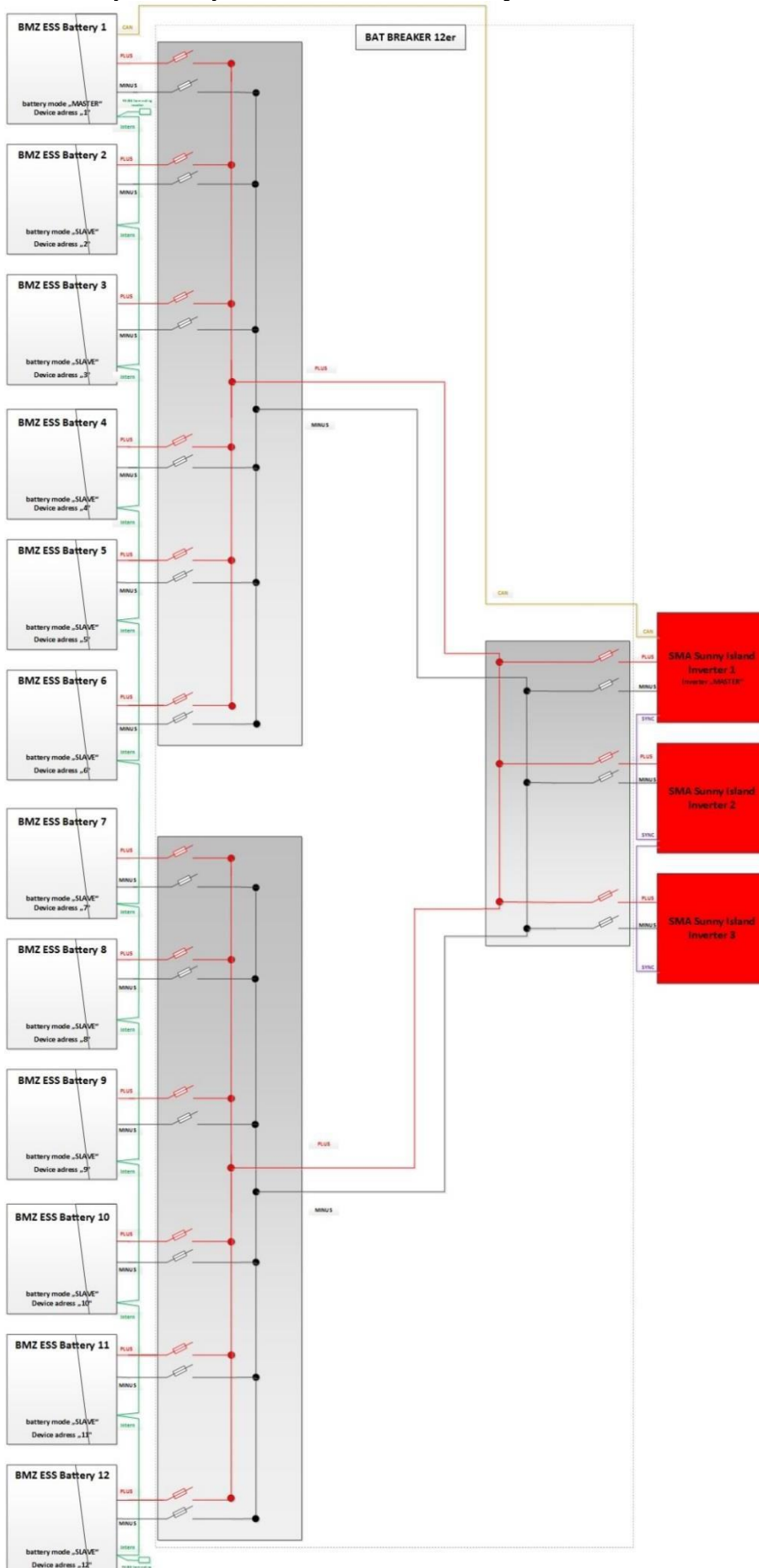

Figure 4-26: 3-phase operation on 12 ESS batteries

## 4.8 Configuration of the ESS battery

### 4.8.1 System structure

- In a complete system of batteries connected in parallel, configure **one battery** as a “**master**”.
- In a complete system of batteries connected in parallel, configure **all other batteries** as “**slave**”.
- You can connect up to 6 batteries with each other in parallel.

### 4.8.2 Addressing the batteries

- Configure each battery with an unambiguous and unique address.  
Numbers 1 to 12 are available.

**Note: Each battery must have a different bus address (device address).**

**Note: Do not use Device address “0”.**

## 4.9 Definition of the battery mode during commissioning and parameter configuration

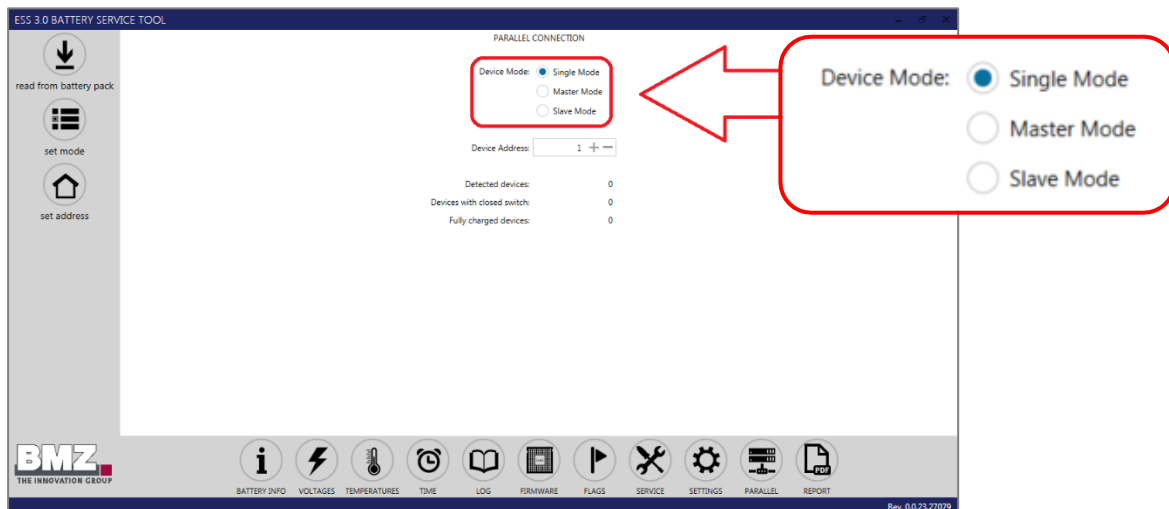

Figure 4-27: representation of the BMZ ESS service tool

### 4.9.1 Single:

This is the delivery status of every BMZ ESS battery ex-works.

The mode is used for the status: 1 BMZ ESS battery operated with one SMA Sunny Island inverter.

### 4.9.2 Master:

This is the status of a BMZ ESS battery in a group of multiple BMZ ESS batteries connected in parallel.

**Important:** Only one battery may be configured as a master.

The mode is used for the status: multiple BMZ ESS batteries are operated with one or more SMA Sunny Island inverters.

### 4.9.3 Slave:

This is the status of multiple BMZ ESS batteries in a group of multiple BMZ ESS batteries connected in parallel.

**Important:** Each battery, except the master battery, must be configured as a slave battery.

The mode is used for the status: multiple BMZ ESS batteries are operated with one or more SMA Sunny Island inverters.



## 4.10 Work step sequence to configure the parameters of batteries

Execute the following steps to configure the parameters of batteries for a system comprising ESS batteries connected in parallel.

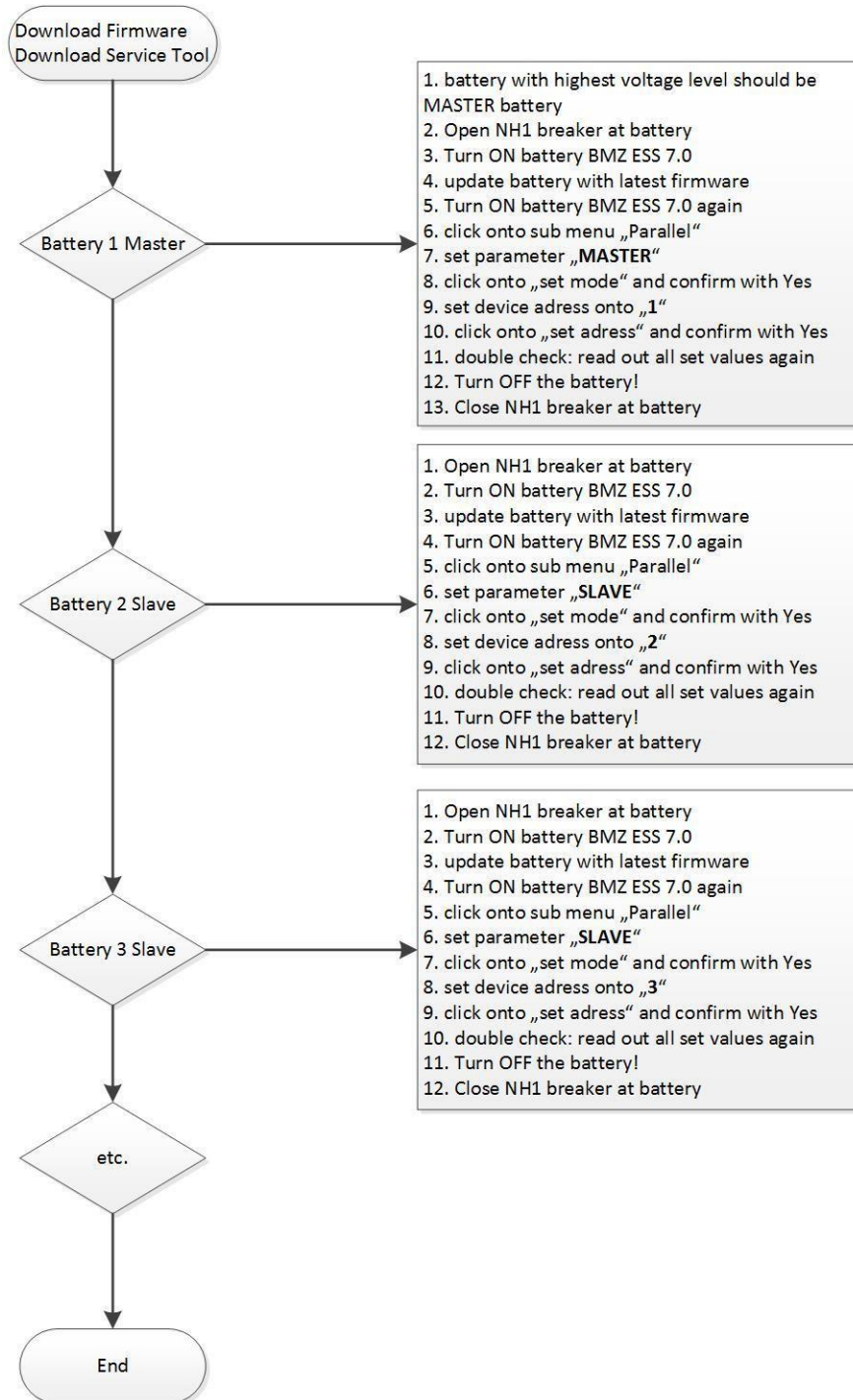

Figure 4-28: representation of the work sequence to configure the parameters of a BMZ ESS battery

## 4.11 Work step sequence to commission the batteries

Execute the following steps to commission a system comprising ESS batteries connected in parallel.

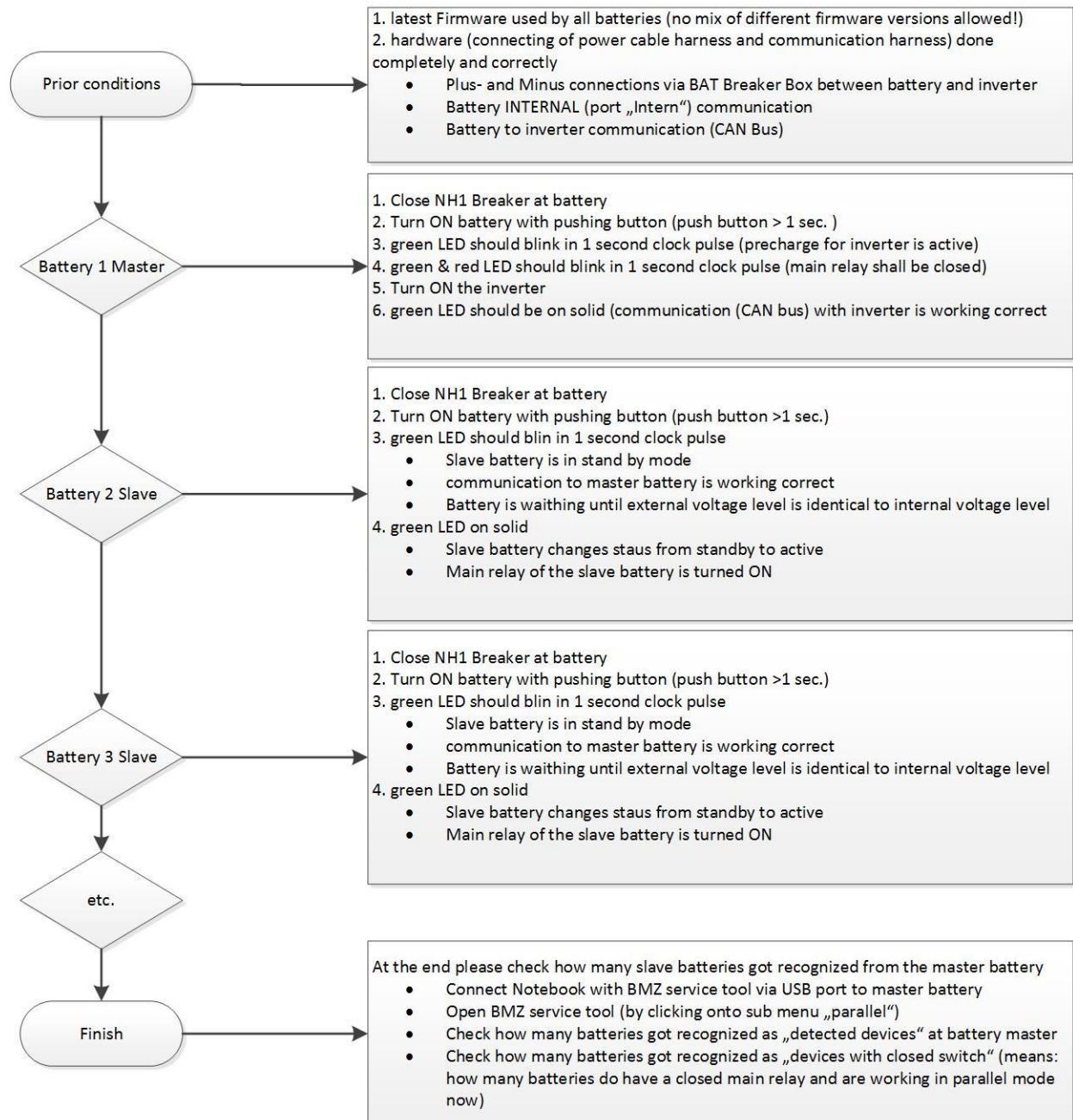

Figure 4-29: representation of the work sequence to commission a BMZ ESS battery

## 4.12 Configuration of firmware for parallel mode

Use the BMZ service tool to configure the battery using the USB service port.

The following files must be available to configure the battery parameters:

- ESS30ServiceTool.exe (example: current service tool V0.0.26)
- System.Windows.Interactivity.dll
- Optional for firmware update: 31502A\_V206.flash (example: current firmware V2.06)

**Important:** All three files must be in the same folder.

Name	Änderungsdatum	Typ	Größe
31502A_V203.flash	22.03.2016 14:13	FLASH-Datei	113 KB
ESS30ServiceTool.exe	01.04.2016 15:04	Anwendung	3.157 KB
System.Windows.Interactivity.dll	26.02.2016 15:50	Anwendungserwe...	55 KB

Figure 4-30: file structure of the BMZ ESS service tool

#### 4.12.1 Setting the master battery mode

In a group of multiple BMZ ESS batteries connected in parallel, configure **one battery** as a **master**.

**Important:**

1. Set the “**Master**” mode and configure the battery parameters by **clicking** on “**set mode**”.
2. In a group of multiple BMZ ESS batteries connected in parallel, **only one battery** may be configured as a master.

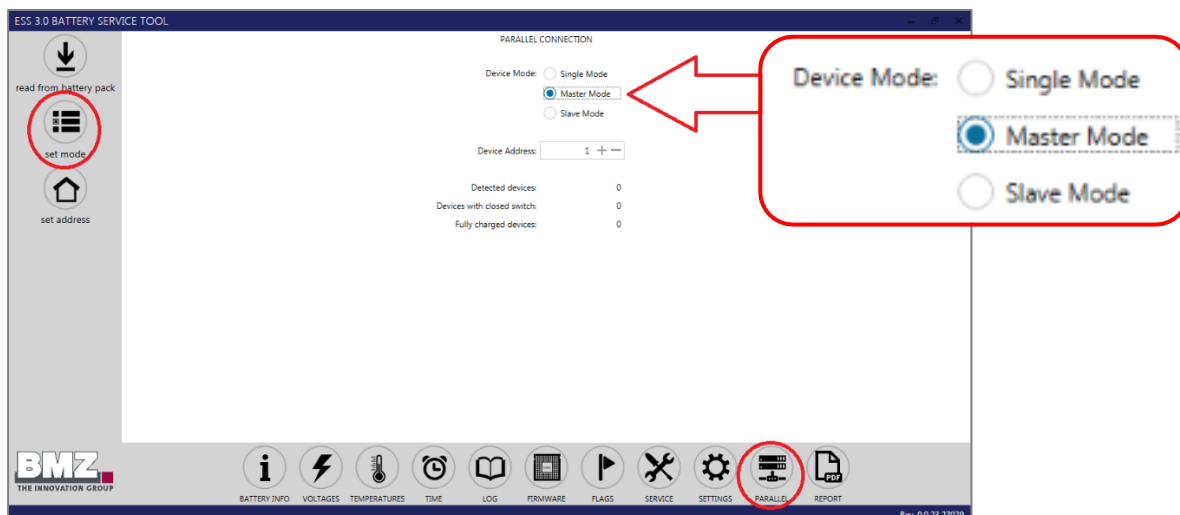

Figure 4-31: representation of configuration of the parameters of a BMZ ESS battery

3. **IMPORTANT:** Configure the parameters of the battery with the lowest voltage level and the lowest charge status as the master battery.

#### 4.12.2 Setting the master battery address

- Address 0 is the default address. Do not use Address 0. Type in + or – to get to device address 1 or higher.
- Each battery connected in parallel must have an unambiguous and unique address (device address).
- The master and slave batteries function only with the addresses configured with numbers from 1 to 12.

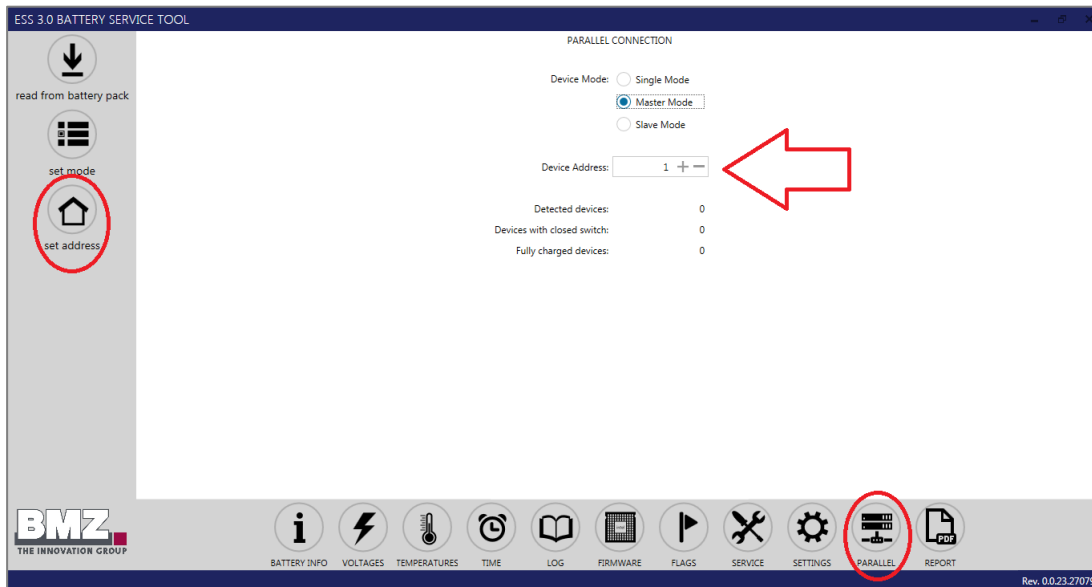

Figure 4-32: representation of configuration of the parameters of a BMZ ESS battery

**Important:**

1. Set the “address” (device address) to “1” and configure the battery parameters by clicking on “set address”.
2. In a group of multiple BMZ ESS batteries connected in parallel, **only one battery** may have the address “1”.
3. If you use device address “1” please make sure that you typed in “+” and “-” before so that “1” will be recognized from the battery BMS.

### 4.12.3 Setting the slave battery mode

In a group of multiple BMZ ESS batteries connected in parallel, configure all batteries, except the master, as slaves.

**Important:**

1. Set the “Slave” mode and configure the battery parameters by clicking on “set mode”.

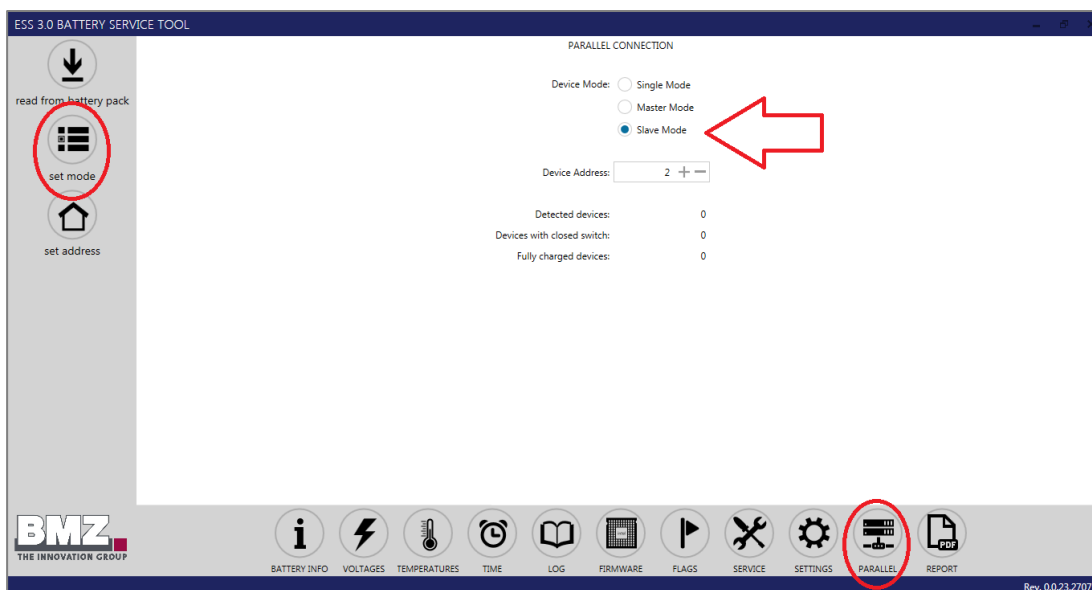

Figure 4-33: representation of configuration of the parameters of a BMZ ESS battery

#### 4.12.4 Setting the slave battery address

- Address 0 is the default address.
- Each battery connected in parallel must have an unambiguous and unique address (device address).
- The master and slave batteries function only with the addresses configured with numbers from 1 to 12.

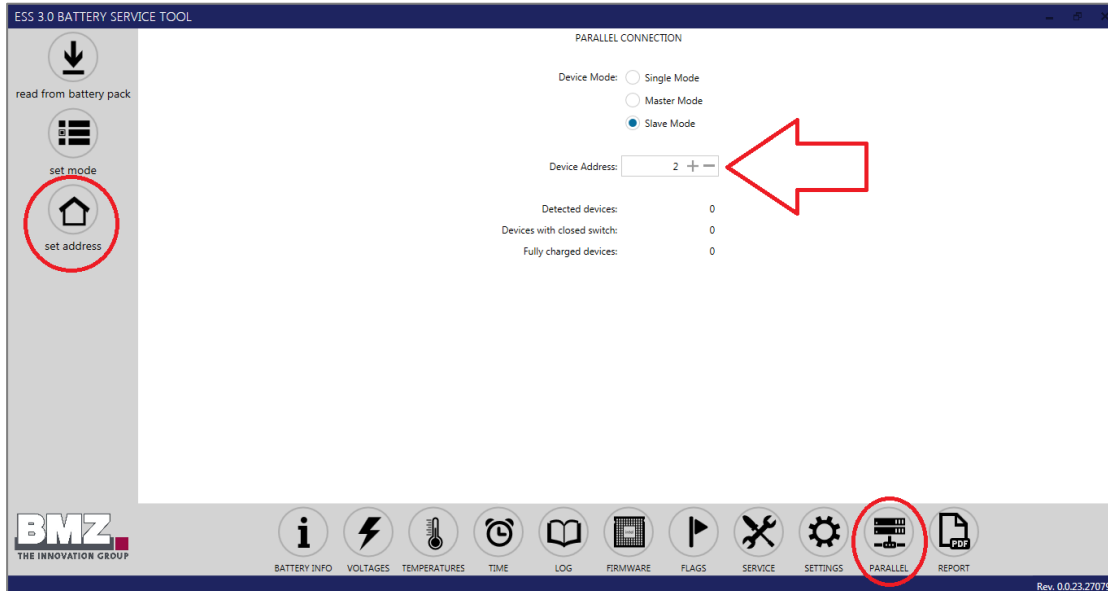

Figure 4-34: representation of configuration of the parameters of a BMZ ESS battery

#### Important:

1. Set the “address” (device address) to “2” and configure the battery parameters by clicking on “set address”.
2. In a group of multiple BMZ ESS batteries connected in parallel, **only one battery** may have the address “2”.
3. Configure a unique and unambiguous address (device address) for all other slave batteries.

### 4.13 Commissioning the parallel connection of multiple batteries

#### 4.13.1 Switch-on sequence

1. At the time of **commissioning**, **first switch on the master battery**.
2. Check whether the **main relay** of the **master battery** is **switched on**
  - ⇒ Check via LED flashing speed (see section 5.1) or BMZ service tool (see section 4.4)
3. **If the main relay of the master battery is closed, you can now switch on other slave batteries.**

#### 4.13.2 Stand-by mode of a slave battery:

When you switch on the slave batteries, the batteries are automatically in the stand-by mode. (The stand-by mode is indicated by a green flashing LED) Only when the master sends a switching signal for the main relay of the slave battery, the main relay of the slave battery is switched on. The slave battery can be used the complete battery system only after this.

#### 4.13.3 Switch-on criterion of the slave battery:

Each battery compares the internal battery voltage with the externally applied voltage through a measurement.

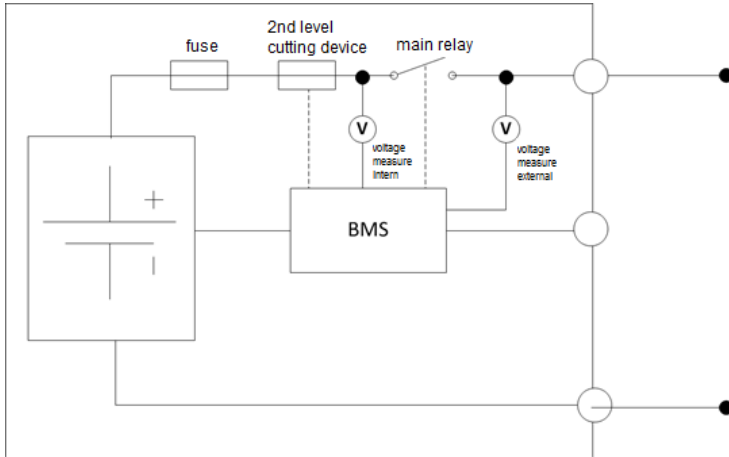

Figure 4-35: block circuit diagram of the BMZ ESS slave battery

If the voltage automatically measured by the battery at the master battery differs from the slave battery voltage by less than +/-100 mV, the slave battery switches off automatically.

**Important:**

To ensure that all slave batteries are activated from the master battery in case of a different voltage level for different batteries, change the charge status of the master battery by charging and discharging using the inverter.

Within a full cycle (i.e. the battery is completely charged once and completely discharged once), the master battery scans all slave batteries in the stand-by mode and switches them off one by one.

This process may take a few hours depending on the available PV energy or loads in the company network.

**4.13.4 Example 1:**

6 batteries connected in parallel with different charge statuses:

- The master battery is switched on and the main relay is switched on
- 2 slave batteries are switched on and the main relay is switched on
- 3 slave batteries are switched on and the main relay is NOT switched on

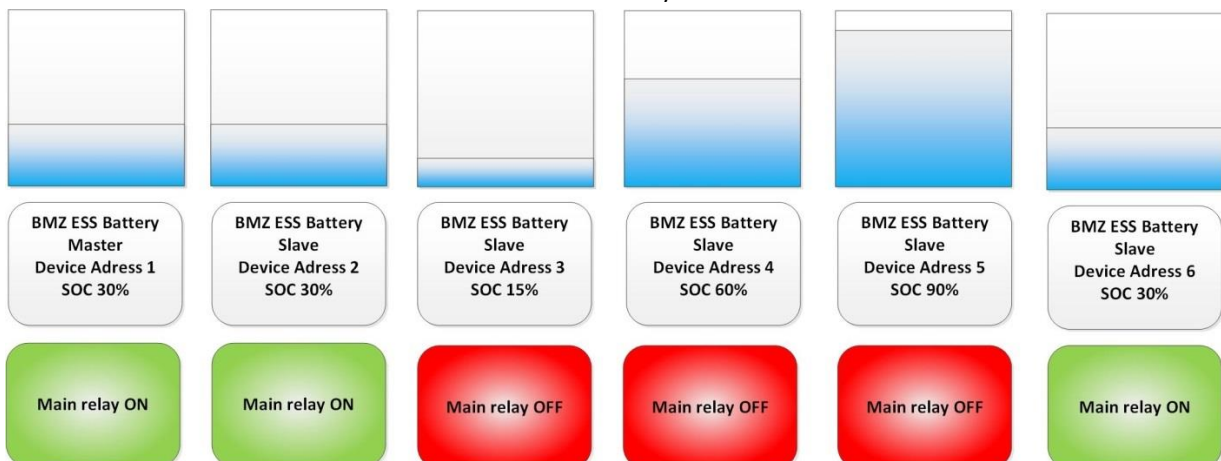

Figure 4-36: representation of example 1, different SOC of BMZ ESS batteries connected in parallel



### 4.13.5 Example 2:

6 batteries connected in parallel with different charge statuses:

- The master battery is switched on and the main relay is switched on
- 4 slave batteries are switched on and the main relay is switched on
- 1 slave battery is switched on and the main relay is NOT switched on

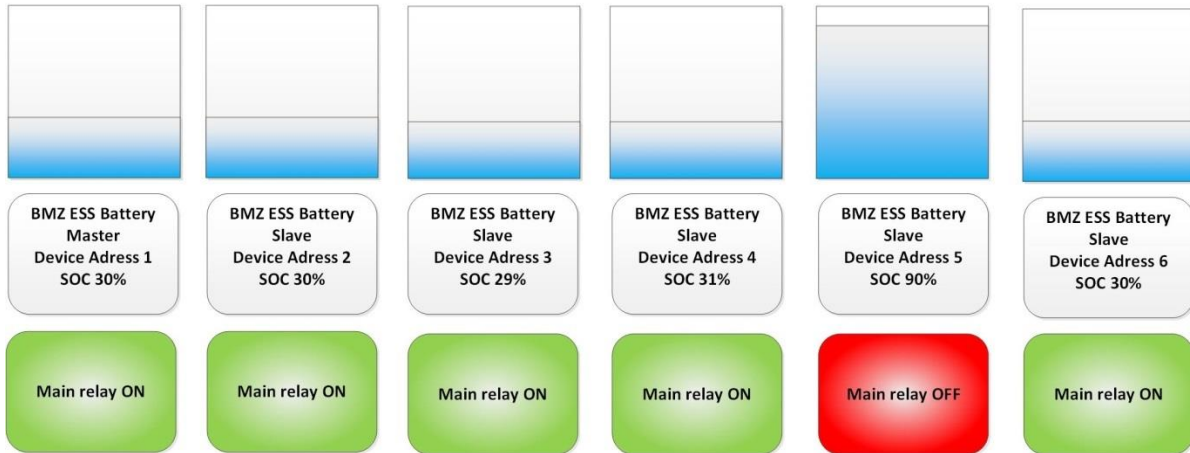

Figure 4-37: representation of example 2, different SOC of BMZ ESS batteries connected in parallel

### 4.13.6 Example 3:

6 batteries connected in parallel with different charge statuses:

- The master battery is switched on and the main relay is switched on
- 5 slave batteries are switched on and the main relay is switched on

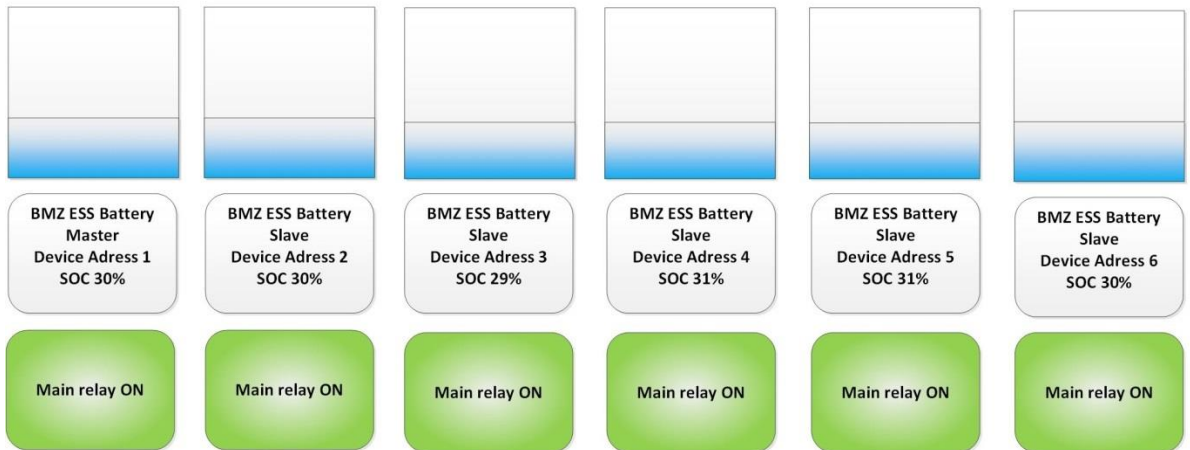

Figure 4-38: representation of example 3, different SOC of BMZ ESS batteries connected in parallel

## 4.14 Checking the parallel connection of multiple batteries

### 4.14.1 Check the number of connected (detected) batteries

- Connect the notebook to the master battery.
- The “Detected devices” number shows the number of batteries connected to the master (and that are in the stand-by mode).

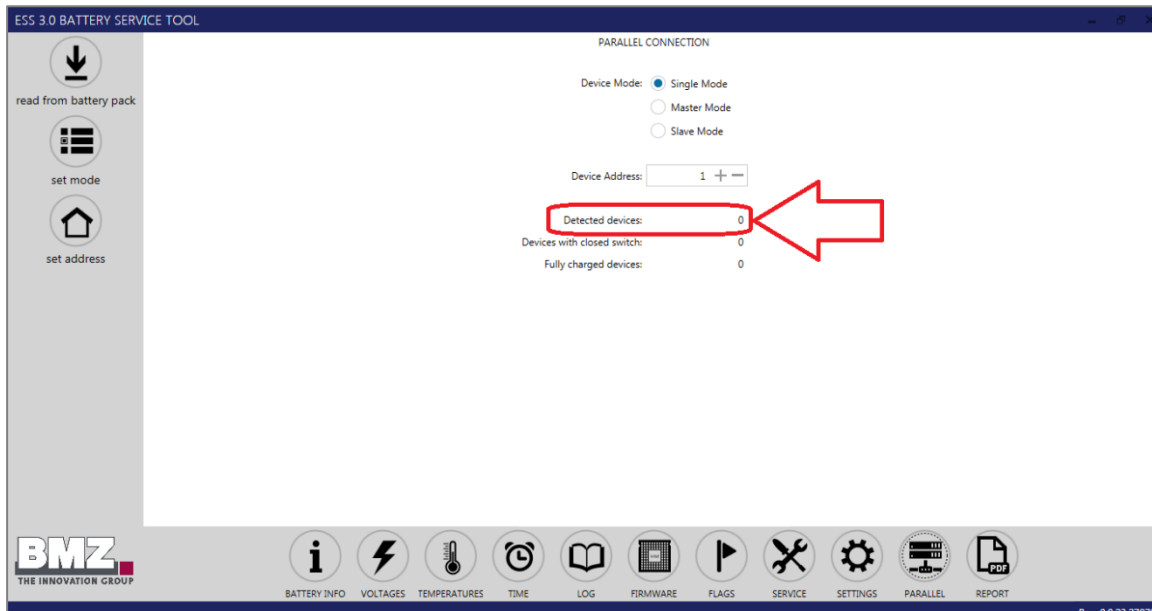

Figure 4-39: check the number of BMZ ESS batteries connected in parallel

**Other test criterion:** The LED of a battery in the stand-by mode flashes green.



#### 4.14.2 Check the number of batteries for which the main relay is closed

- Connect the notebook to the master battery.
- The “Devices with closed switch” number shows the number of batteries connected to the master for which the main relay is closed.
- These batteries are connected in parallel to the master battery and can thus be used in the complete system (charging and discharging).

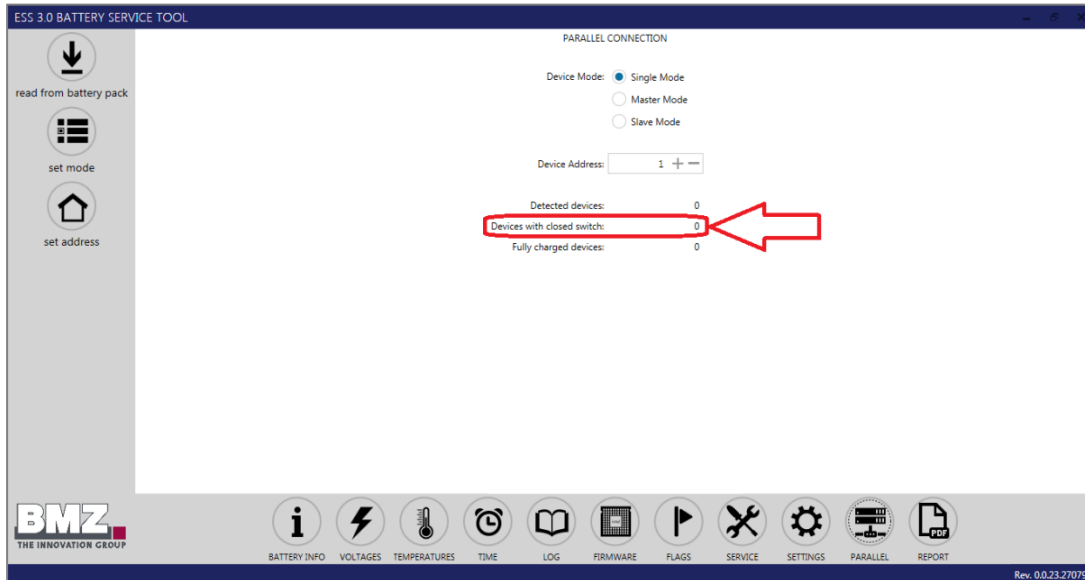

Figure 4-40: check the number of BMZ ESS batteries connected in parallel

**Other test criterion:** The LED of a battery in the parallel mode (active) continuously lights up in green.

### 4.15 Adding new batteries

BMZ allows subsequent extensions of the battery system until six months after the first installation.

- 1) Configure a new battery as a slave
- 2) Disconnect the NH isolator of the output rail
- 3) Disconnect the NH isolator of the battery
- 4) Connect the power cable of the slave battery to the output rail.
- 5) If the new slave battery is switched on, switch it off by pressing the button for 10 seconds (LEDs must be off)
- 6) Connect the NH isolator of the battery
- 7) Connect the NH isolator of the output rail
- 8) Switch on the slave battery using the button (press the button for > 1 second, LEDs flash)

After adding a new battery, you may still need to deal with the equalising currents. This may lead to the adjustment of the capacity even if no current flows from or to the inverter.

### 4.16 Checking the connections of parallel battery systems





Check the connections as per the exact specifications in the installation check list given in the annexe.

#### 4.16.1 Switching the battery storage system on and off

The battery storage system and the inverter must be correctly installed before they can be put into operation.

## Switch on the battery storage system using a switch

Proceed as follows to start the battery storage system:

Step	Description
1	Open the screws on the service flat using a PH2 screwdriver.
2	Check whether the NH isolator is equipped with correct (see section 4.5) NH fuses and put into operation correctly.
3	Check the connections of the DC power cable (+, -) and the CAN communication cable of the battery inverter.
4	<p>Actuate the push button through a short (longer than 1 second) push.</p>  <p> A clicking sound must be heard.</p>
5	<p>Check the LED status of the battery storage system.</p> <ul style="list-style-type: none"> <li>The green LED flashes quickly (every 150 msec): The pre-charging path is activated and charges the capacitors of the inverter. (The pre-charging time depends on the type and number of connected inverters. The pre-charging time can take from 30 seconds to 2 minutes)</li> <li>For slave batteries: The green LED flashes slowly (every 1 second): The battery is active and waits for the switch-on signal of the master battery.</li> <li>Both LEDs flashes slowly (every 1 second): The battery is active and waits for communication through the inverter.</li> </ul> <p> The battery switches off automatically after 20 minutes if there is no communication between the battery and the inverter.</p> <p> Additional information regarding the LED flashing patterns is given in the Pilot lamps section, page 71.</p>
6	<p>Switch on the battery inverter.</p> <ul style="list-style-type: none"> <li>The green LED lights up continuously</li> </ul> <p> If there is no communication between the battery storage system and the inverter, the battery switches off automatically after 20 minutes to avoid erroneous operating modes. Both LEDs flash in a one-second cycle if there is no communication.</p>
7	<p><b>Important: (see chapter 4.14.1)</b></p> <p>At the time of <b>commissioning</b> of batteries connected in parallel, <b>first switch on the master battery.</b></p> <ol style="list-style-type: none"> <li>Check whether the <b>main relay of the master battery is switched on</b> -&gt; Check via LED flashing speed (see section 5.1) or BMZ service tool (see section 5.2)</li> <li><b>If the main relay of the master battery is closed, you can now switch on other slave batteries.</b></li> </ol> <p><b>If the switch-on sequence for batteries connected in parallel is not followed, it may happen that none of the batteries allow switching off the main relay.</b></p>



### Switch on the battery storage system using an external voltage source

Proceed as follows to start the battery storage system:

Step	Description
1	The external voltage source can be used to switch on the system only if it was not switched off using the push button (press the push button longer than 10 seconds at a stretch).
2	Connect an external voltage source greater than 36 VDC.
3	The battery detects the external voltage source automatically and switches the operating mode from inactive to active.
4	If it is switched on in an unauthorised manner, the green LED flashes quickly (100 ms flash cycle) You must now start the battery using a normal switch-on sequence (by pressing the push button longer than 1 second).

### Switch off the battery storage system using a push button

Proceed as follows to switch off the battery storage system:

Step	Description
1	Open the screws on the service flat using a PH2 screwdriver.
2	Keep the switch-on button pressed for at least 10 seconds. 
3	After approximately 8 seconds, both LEDs start flashing quickly (100 ms flash cycle).  Keep the button pressed for 2 more seconds.
4	The LEDs switch off. The battery storage system is now switched off.  A clicking sound must be heard.

### Switch off the battery storage system using time

The battery switches off automatically after a defined time of 20 minutes when the battery does not detect any CAN communication externally.

Step	Description
1	If an external source (e.g. the battery inverter) does not detect a CAN communication of the battery, the battery switches off automatically after 20 minutes.
2	Optional: If the battery is installed in <b>parallel mode</b> , the battery defined as master first switches off after 20 minutes without CAN communication of the external source. The slave battery then switches off after 20 minutes. If a master or a slave battery is now switched on in the parallel mode, all batteries in the complete system are switched on since they are activated by the pre-charging voltage of the battery that is switched on first (see Switching on the battery storage system using an external voltage source

### 4.16.2 Configuring the parameters of the inverter

The inverter parameters must be configured for the BMZ ESS battery in order to operate it optimally in combination with the inverter.

See section 4.18

## 4.17 Recommended parameters of the inverter

To ensure the optimum working range of the battery and to optimise the quantity of storable energy, BMZ recommends the following parameters for the inverter.

 A detailed description of parameters is given in the operating manual of your SMA Sunny Island inverter.

### 4.17.1 SMA Sunny Island with Sunny Control Module

#### Default settings

1. Enter the following values in the quick configuration guide during the basic configuration of the Sunny Island inverter (see the documentation of the system):
  - Battery type **BatTyp**: Lilon\_Ext-BMS
  - Battery capacity **BatCpyNom**: For Ah values see type plate on the battery's backside (C10). Multiply the value for each battery in parallel.

2. After the basic configuration of the Sunny remote control, turn the knob and select the input page **password (1/1)**.

```

Password <1/1>#
Level      User
    
```

3. Press the knob. This will take you to the input page.

```

Password <1/1>
Set      10 #
Runtime  1234 h
    
```

4. Calculate the checksum of the **Runtime** operating hours. Determine the installer password.
  - Example: The **Runtime** operating hours are **1234 h**. The checksum is the sum of all digits:  
 $1 + 2 + 3 + 4 = 10$

5. Select **Set** on the Sunny remote control and press the knob.
6. Set the determined installer password and press the knob. The Sunny remote control is in the installer mode.

```

Installer
100# Meters      #
200# Settings
300# Diagnosis
    
```

7. Select the **700# Operator Level** menu and press the knob.

```

Installer
500# Operation
600# Direct Access
700# Operator Level#
    
```

8. Select the **700.01 ActLev** parameter, press the knob and set to **Expert**.

```

Operator Level
700#01 <Set>#
      ActLev
      Expert
    
```

9. Confirm the **<accept Y/N>** query with **Y**.

10. Set parameters for on-grid operation (Figure 4-41) or off-grid operation (Figure 4-42):

### On-grid application optimized for self-consumption

Number	Name	Systems optimized for self-consumption	Backup power systems optimized for self-consumption
261.03	Saisonenable	No	No
262.01	ProtResSOC	3 %	3 %
262.02	BatResSOC	2 %	2 %
262.03	BUResSOC	Not available	1 %
262.04	PVResSOC	5 %	5 %
262.05	MinSlfCsmplSOC	90 %	89 %

Figure 4-41: SMA Parameter on-grid with Sunny Control Module

### Off-grid application

In expert mode, the following parameters should be set when installing the inverter:

Number	Name	Value
235.xx	Diesel Generator Start	12 % SOC
242.xx	Load Shedding	10 % SOC
223.07	Bat Pro 3	3 % SOC
223.06	Bat Pro 2	5 % SOC
223.05	Bat Pro 1	7 % SOC

Figure 4-42: SMA Parameter off-grid with Sunny Control Module

#### 4.17.2 Learning cycle

In order to optimize its efficiency, the battery automatically undergoes a learning cycle to determine the usable capacity.

During the learning cycle, the battery should go through the SOC limits 100 % and 12 % as often as possible.

The learning cycle starts at 100 % SOC and ends at 12 % SOC. If both events occur sequentially and no more than 20 % SOC energy has been charged in between, the learning cycle is considered "successfully completed".

The more often this learning cycle is completed, the more precise is the SOC calculation.

The more often this learning cycle is completed, the more energy the battery can store and release.

## 5 Operation and service software

### General safety instructions

Please follow the safety instructions in the Safety section, page 10.

### 5.1 Pilot lamps (LED)

#### 5.1.1 LED indicators on the battery module

The pilot lamps on the battery module indicate the possible statuses and incidents in the operation of the battery storage system.

Colour pattern	Flashing frequency	Function
OFF	OFF	The battery is switched off
Green + Red	Continuously lit up	Service mode (a PC is connected)
	Quick flashing (100msec)	The battery is in error mode <ul style="list-style-type: none"> <li>The relay is tripped and cannot be switched on</li> <li>For example, the temperature is too high</li> <li>For example, the temperature is too low</li> <li>For example, charge status of battery is too low</li> </ul> <b>Please contact the BMZ Service immediately (see section (7))</b>
	Slowly flashing (1sec)	The battery is switched on, but no communication with the inverter. <ul style="list-style-type: none"> <li>(Countdown of 20 minutes until the battery is switched off)</li> </ul>
Green	Continuously lit up	The battery is switched on (normal mode) <ul style="list-style-type: none"> <li>The relay is pulled</li> <li>The inverter is fed via Softstart (pre-charging branch)</li> <li>No error</li> </ul>
	Slowly flashing (1sec)	Pre-charging is activated. (Normal mode) <ul style="list-style-type: none"> <li>The pre-charging path for charging the capacitors of the inverter is activated</li> </ul> The relay is still not pulled
	Slowly flashing (1sec)	SLAVE battery (normal mode) <ul style="list-style-type: none"> <li>The pre-charging path for charging the capacitors of the inverter is activated</li> <li>The relay is still not pulled (master not active)</li> <li>The battery is in stand-by mode and switches off <b>automatically</b> as soon as the master is activated.</li> </ul>
Red	Quick flashing (100ms)	The battery is in error mode <ul style="list-style-type: none"> <li>The relay is tripped and cannot be switched on</li> <li>The 2nd protection switch element (Pyrofuse) has tripped</li> </ul> <b>Please contact the BMZ Service immediately (see section (7))</b>

Figure 5-1: Pilot lamps table (LED)

### 5.1.2 Charging status indicator

The charging status indication is given using the communication line via the inverter.

## 5.2 Connection of the notebook for servicing



### 5.2.1 USB port



Each rechargeable battery set has a USB port.

The installer can use this port to execute the following steps:

- Update (firmware)
- Read error memory

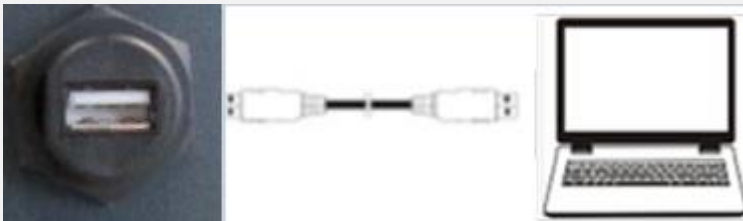
Proceed as follows to read the battery storage system via the USB port:

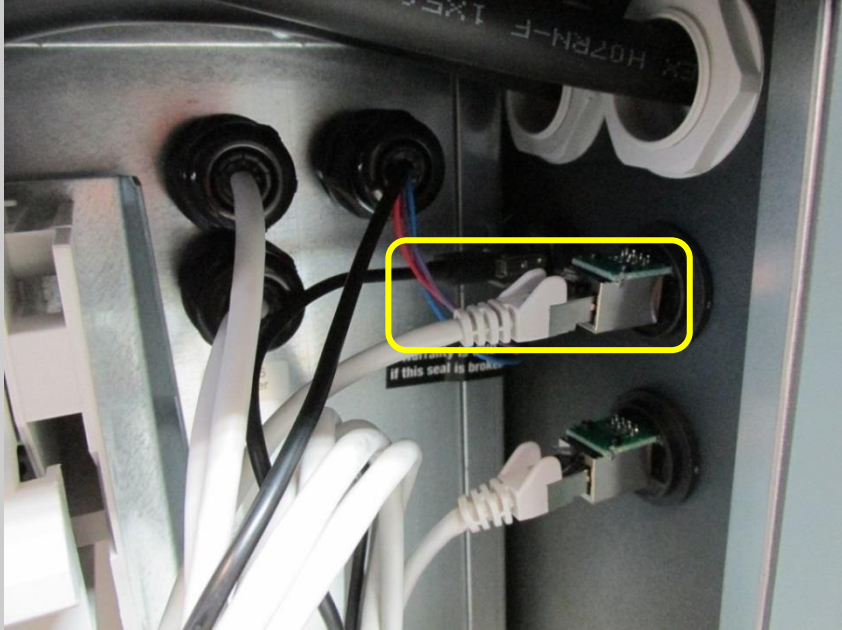
Step	Description
1	<p>Open the screws on the service flat using a PH2 screwdriver. Loosen and remove the upper fillister-head screw of the lateral service flap.</p>  <p><i>Figure 5-2: side view of BMZ ESS, service flap</i></p>
2	<p>Now push the flap of the side panel upwards to remove it.</p>
3	<p>Switch off the battery system.</p>  <p><i>Figure 5-3: push button with LEDs</i></p> <p> Both LEDs must <b>not</b> light up.</p>
4	<p>Pull out the NH fuses of the NH isolator and remove the safety bracket and fuses from the isolator.</p>
5	<p>Connect the notebook to the battery storage system. Connect the USB A cable of the notebook to the USB A port of the battery storage system.</p>  <p><i>Figure 5-4: USB communication</i></p>

<p>5a</p>	<p>This step is applicable if there is no communication between the battery storage system and the notebook. Connect the USB cable directly from the battery storage system.</p>  <p><i>Figure 5-5: USB port of BMZ ESS battery, inner side of housing</i></p> <p>Loosen the cable binder of the USB cable carefully using a side cutter and pull the USB plug internally from the socket (rear wall).</p>
<p>6</p>	<p>Connect the notebook with the battery storage system using the USB cable.   The notebook must not be connected with the AC grid via the charging cable.</p>
<p>7</p>	<p>Switch on the battery storage system using the push button.</p>  <p><i>Figure 5-6: push button and LEDs</i></p>
<p>8</p>	<p>The service software can now be installed and started.</p>

### 5.2.2 Service software

The software is easy to operate and works with all commonly used Windows versions.

The following functions are possible

- Read battery status (cell voltages, temperatures)
- Firmware update
- Configuration of the battery for parallel mode
- Download log files (for sending to the Service Department via email)
- Prepare PDF report (actual status of the battery)

**For more information regarding the service software, please refer to the operating manual of the BMZ service tool. It is a separate document.**

**Please contact BMZ GmbH for this purpose.**



## 6 Fault/damage event

### 6.1 Fault indicators

#### 6.1.1 Fault indicators of pilot lamps

---

##### Fault indicators of pilot lamps

Two LEDs are provided on the battery storage system.

In case of errors in the battery storage system, they either individually flash in red or flash together in red and green. Detailed information regarding the flashing pattern is given in the Pilot lamps section (page 70).

---

##### Fault indicators of the battery via the inverter

Detailed information regarding error codes displayed by the inverter are given in the corresponding section of the operating manual of the inverter manufacturer.

### 6.2 Actions to be taken in case of a damage

---

#### General information

If the battery storage system is used for the intended purposes, lithium ion batteries do not pose any risk.

If cells and the housing are damaged, there is a risk of contact with electrolytes.

 **WARNING**



**Possible risk to life due to leaking electrolytes.**

If you do not observe the following behavioural instructions, they may cause material damage and personal injuries; BMZ GmbH shall not bear any liability in such a case.

- Switch off the battery storage system if it is possible without any risk.
- Ensure adequate ventilation outside.

**Prevent these hazardous situations. Otherwise, they may lead to deaths or serious injuries.**



Please follow the safety data sheet of the BSW: "Use of stationary lithium solar power accumulators" under [www.solarwirtschaft.de](http://www.solarwirtschaft.de)

#### 6.2.1 First aid measures

If the battery storage system and the battery modules installed in it are damaged, please initiate the following first aid measures:

---

##### Contact with skin and eyes:

- Skin irritations may occur. Wash the skin thoroughly with soap and water.
- Irritations in eyes may occur. Wash eyes thoroughly with water for 15 minutes and then visit a doctor.

---

**Respiratory tracts:**

- Generated gases may damage respiratory tracts.
- Ventilate immediately or go in fresh air; in worst cases, call a doctor immediately.

---

**Burns:**

- Do not touch the injured person until the de-energised status of the system is ensured
- Take freely lying live cables away from the injured person using non-conductor objects
- Ensuring breathing and the functioning of cardiovascular system is utmost important in case of unconscious patients. If necessary, initiate cardiopulmonary resuscitation immediately
- Let the burn injuries of responding patients cool and cover them with a sterile wound dressing

## 7 Service and maintenance activities

---

### General information

The manufacturer recommends a regular annual maintenance of the battery system.

Check the following points while doing this:

- Operate the battery with the current firmware
- Battery does not have external damage
- Air circulation outside and inside the battery is possible without any problem.
- Ventilation is clean and accessible
- Histogram of temperature progressions is not problematic and within the permissible temperature range of the battery (see section 5.2)

A deviation from normal operation is shown by the battery indicator of the inverter. The battery has an independent error memory that can be read by an expert authorised by BMZ GmbH.

If you have any queries regarding this, please contact BMZ Service.

---

### BMZ Service Center Germany

If you have queries regarding the BMZ ESS system or require help, you can always contact the BMZ Service Center.

#### Business hours

Monday to Friday	08:00 AM	to	4:00 PM
Saturday, Sunday and holidays:	Closed		

#### Contact:

Service telephone	+49 (0) 6188 99 56 9830
Fax	+49 (0) 6188 99 56 699
Website:	<a href="http://www.bmz-central-service.com">www.bmz-central-service.com</a>
Email:	<a href="mailto:CS.BigPack@bmz-group.com">CS.BigPack@bmz-group.com</a>

---

### BMZ Service USA

#### Contact

Phone	+1 757 821 8494
Fax	+1 757 821 8499
Email:	<a href="mailto:Service.USA@bmz-group.com">Service.USA@bmz-group.com</a>

## 7.1 Complaint handling

1. Contact a solar technician of BMZ Service via hotline +49 (0)6188 9956-9830 or email [CS.BigPack@bmz-group.com](mailto:CS.BigPack@bmz-group.com).
2. BMZ Service asks solar technicians for the data of the memory (SN, pdf report and log file) -> service tool is required.
3. If it is not available, BMZ Service will send you the latest FW of the service tool and the complaint order free of charge.
4. The solar technician shall fill in the complaint order completely and send it along with the following documents to [CS.BigPack@bmz-group.com](mailto:CS.BigPack@bmz-group.com):
  - Pdf-report of the battery
  - Error.log file
  - Log file of the battery (data from a 10-minute download is sufficient)
  - Installation checklist
  - Proof of purchase / original invoice
5. The solar technician will sign the complaint order to acknowledge that he/she has informed his/her wholesaler about this complaint.
6. If necessary, BMZ Service shall send a packing kit via a forwarding agency
7. If the solar technician packs the solar storage unit in a ready-to-dispatch condition, BMZ Service shall arrange for the pick-up from the solar technician.
8. BMZ Service shall pick up the storage unit from the solar technician, repair it and send it back to the solar technician (if the solar technician cannot rectify the problem).
9. In irreparable cases, BMZ Service shall send a replacement device and pick up the defective storage unit from the solar technician.
10. Business relationships exist only between BMZ and the OEM or its associated authorised dealers (solar technicians, dealers).
11. Direct complaint handling through end customers is ruled out.

If you have questions, please contact:

**Tel. +49 (0) 6188 9956-9830 or [CS.BigPack@bmz-group.com](mailto:CS.BigPack@bmz-group.com)**

## 8 Warranty conditions

Please contact your authorized dealer for the local warranty conditions.

## 9 Dismantling and disposal

### Introduction

This section describes the dismantling and disposal process for the battery storage system.

### 9.1 Disposal of the battery storage system

#### Risk of damage

Only the experts should dismantle the system.

Used batteries are collected by the distributor. Please contact the BMZ Service Center (Tel: +49 (0) 6188 9956 9830, email: CS.BigPack@bmz-group.com) regarding used batteries.

**⚠ CAUTION**



**WARNING AGAINST POISONOUS MATERIALS.**

Numerous materials have been used in the battery storage system. Some of them may cause damage to people and the battery storage system if not handled properly.

Always follow the local regulations for waste disposal.  
Appoint an authorised disposal company for professional disposal.

Prevent these hazardous situations. Otherwise, **they may lead to insignificant or minor injuries.**

#### Degree of risk of materials

Material group	Degree of risk
Non-ferrous metal	High to very high
Stainless steel	Moderate
Plastics	Moderate
Electronic scrap	High
Batteries	Very high
Cables and lines	High

## 10 Annexe

---

### Overview

The annexe contains the following documents:

- Declaration of conformity
- Installation check list

## 10.1 Declaration of conformity

**BMZ GMBH**  
Am Sportplatz 28 · D-63791 Karlstein am Main  
Tel: +49 (0)6188 9956-0 · Fax: +49 (0)6188-9956-900  
E-Mail: mail@bmz-group.com · Internet: www.bmz-group.com



### EC Certification of Conformity

**Company:** BMZ GmbH  
**Address:** Am Sportplatz 28  
63791 Karlstein  
**Product:** Li-ion Battery  
**Designation:** 15S54P US18650V3 55.5V 121.5Ah 6.7kWh  
**Item no.:** 24930-01, 24930-02, 30110-00, 31555-00

We confirm that the designated product corresponds to the substantial requirements of the following European guidelines:

The conformity of the product with the guidelines is proven by the complete compliance to the following mentioned harmonized and not harmonized standards:

#### 2011/65/EC RoHS Directive

Directive of the European Parliament and of the Council on the restriction of the use of certain hazardous substances in electrical and electronic equipment (recast)

#### EN 62133:2013

Secondary cells and batteries containing alkaline or other non-acid electrolytes - Safety requirements for portable sealed secondary cells, and for batteries made from them, for use in portable applications

#### 2014/30/EU EMC Directive

Directive of the European Parliament and of the Council on the harmonisation of the laws of the member states relating to the electromagnetic compatibility

EN 55014-1:2006 + A1:2009 + A2:2011  
EN 55014-2:2015  
EN 61000-3-2:2014  
EN 61000-3-3:2013

Karlstein am Main, 05.12.2017

Sven Bauer, Managing Director

i.V. Dirk Oestreich, Director R&D

This declaration certifies compliance with the above mentioned directives but does not include a property assurance.

**Geschäftsführer**  
HRB-Nr. 5890 Aschaffenburg  
Commerzbank  
Sparkasse Aschaffenburg  
Deutsche Bank

**Sven Bauer**  
St. Nr.: 122/50444  
BIC:COBADEFF795  
BIC:BYLADEM1ASA  
BIC:DEUTDEFF508

Ust.-ID-Nr.: DE 811770243  
IBAN:DE35795400490105770200  
IBAN:DE71795500000240004283  
IBAN:DE85508700050010501500

BLZ 79540049 Kto. 1057702  
BLZ:79550000 Kto. 240004283  
BLZ 50870005 Kto. 010501500

Figure 10-1: EC Declaration of Conformity ESS 7.0 (1)



**BMZ GMBH**  
Am Sportplatz 28 · D-63791 Karlstein am Main  
Tel: +49 (0)6188 9956-0 · Fax: +49 (0)6188-9956-900  
E-Mail: mail@bmz-group.com · Internet: www.bmz-group.com



## EC Certification of Conformity

**Company:** BMZ GmbH  
**Address:** Am Sportplatz 28  
63791 Karlstein  
**Product:** Li-ion Battery  
**Designation:** 15S54P NCM18650-22E 55.5V 121.5Ah 6.7kWh  
**Item no.:** 30890-00, 30891-00, 30892-00, 31560-00

We confirm that the designated product corresponds to the substantial requirements of the following European guidelines:

The conformity of the product with the guidelines is proven by the complete compliance to the following mentioned harmonized and not harmonized standards:

### 2011/65/EC RoHS Directive

Directive of the European Parliament and of the Council on the restriction of the use of certain hazardous substances in electrical and electronic equipment (recast)

### EN 62133:2013

Secondary cells and batteries containing alkaline or other non-acid electrolytes - Safety requirements for portable sealed secondary cells, and for batteries made from them, for use in portable applications

### 2014/30/EU EMC Directive

Directive of the European Parliament and of the Council on the harmonisation of the laws of the member states relating to the electromagnetic compatibility

EN 55014-1:2006 + A1:2009 + A2:2011  
EN 55014-2:2015  
EN 61000-3-2:2014  
EN 61000-3-3:2013

Karlstein am Main, 05.12.2017

Sven Bauer, Managing Director

i.V. Dirk Oestreich, Director R&D

This declaration certifies compliance with the above mentioned directives but does not include a property assurance.

**Geschäftsführer**  
HRB-Nr. 5890 Aschaffenburg  
Commerzbank  
Sparkasse Aschaffenburg  
Deutsche Bank

**Sven Bauer**  
St. Nr.: 122/50444  
BIC: COBADEFF795  
BIC: BYLADEM1ASA  
BIC: DEUTDEFF508

Ust-ID-Nr.: DE 811770243  
IBAN: DE35795400490105770200  
IBAN: DE71795500000240004283  
IBAN: DE85508700050010501500

BLZ 79540049 Kto. 1057702  
BLZ 79550000 Kto. 240004283  
BLZ 50870005 Kto. 010501500

Figure 10-2: EC Declaration of Conformity ESS 7.0 (2)

**BMZ GMBH**  
Am Sportplatz 28 · D-63791 Karlstein am Main  
Tel: +49 (0)6188 9956-0 · Fax: +49 (0)6188-9956-900  
E-Mail: mail@bmz-group.com · Internet: www.bmz-group.com



## EC Certification of Conformity

**Company:** BMZ GmbH  
**Address:** Am Sportplatz 28  
63791 Karlstein  
**Product:** Li-ion Battery  
**Designation:** 15S54P US18650NC1 54V 156.6Ah 8.46kWh  
**Item no.:** 32370-00, 33741-00

We confirm that the designated product corresponds to the substantial requirements of the following European guidelines:

The conformity of the product with the guidelines is proven by the complete compliance to the following mentioned harmonized and not harmonized standards:

### 2011/65/EC RoHS Directive

Directive of the European Parliament and of the Council on the restriction of the use of certain hazardous substances in electrical and electronic equipment (recast)

### EN 62133:2013

Secondary cells and batteries containing alkaline or other non-acid electrolytes - Safety requirements for portable sealed secondary cells, and for batteries made from them, for use in portable applications

### 2014/30/EU EMC Directive

Directive of the European Parliament and of the Council on the harmonisation of the laws of the member states relating to the electromagnetic compatibility

EN 55014-1:2006 + A1:2009 + A2:2011  
EN 55014-2:2015  
EN 61000-3-2:2014  
EN 61000-3-3:2013

Karlstein am Main, 05.12.2017

Sven Bauer, Managing Director

i.V. Dirk Oestreich, Director R&D

This declaration certifies compliance with the above mentioned directives but does not include a property assurance.

**Geschäftsführer**  
HRB-Nr. 5890 Aschaffenburg  
Commerzbank  
Sparkasse Aschaffenburg  
Deutsche Bank

**Sven Bauer**  
St. Nr.: 122/50444  
BIC:COBADEFF795  
BIC:BYLADEM1ASA  
BIC:DEUTDEFF508

Ust.-ID-Nr.: DE 811770243  
IBAN:DE35795400490105770200  
IBAN:DE71795500000240004283  
IBAN:DE85508700050010501500

BLZ 79540049 Kto. 1057702  
BLZ:79550000 Kto. 240004283  
BLZ 50870005 Kto. 010501500

Figure 10-3: EC Declaration of Conformity ESS 9.0

**BMZ GMBH**  
Am Sportplatz 28 · D-63791 Karlstein am Main  
Tel: +49 (0)6188 9956-0 · Fax: +49 (0)6188-9956-900  
E-Mail: mail@bmz-group.com · Internet: www.bmz-group.com



## EG-Konformitätserklärung

**Firma:** BMZ GmbH  
**Anschrift:** Am Sportplatz 28  
63791 Karlstein  
**Produkt:** Lithium-Ionen-Batterie  
**Bezeichnung:** 15S54P NCA18650 35E 54V 186,3Ah 10,06kWh  
**Artikel-Nr. :** 37400-00

Für das oben angegebene Produkt bestätigen wir,  
dass es den Anforderungen der folgenden  
Europäischen Richtlinien und Normen entspricht:

Die Übereinstimmung des Produkts mit den Richtlinien  
wird nachgewiesen durch die vollständige Einhaltung der  
angeführten harmonisierten und nicht harmonisierten  
Normen:

### 2011/65/EU RoHS-Richtlinie

Richtlinie des Europäischen Parlaments und des Rates  
zur Beschränkung der Verwendung bestimmter  
gefährlicher Stoffe in Elektro- und Elektronikgeräten

### EN 62133:2013

Akkumulatoren und Batterien mit alkalischen oder anderen  
nicht säurehaltigen Elektrolyten - Sicherheitsanforderungen  
für tragbare gasdichte Akkumulatoren und daraus  
hergestellte Batterien für die Verwendung in tragbaren  
Geräten

### 2014/30/EU EMV-Richtlinie

Richtlinie des Europäischen Parlaments und des Rates  
zur Angleichung der Rechtsvorschriften der Mitgliedstaaten  
über die elektromagnetische Verträglichkeit

DIN EN 55014-1:2016  
DIN EN 55014-2:2015  
DIN EN 61000-4-2:2009  
DIN EN 61000-4-3:2011  
DIN EN 62233:2008 + Ber.1:2009

Karlstein am Main, 03.04.2018

Sven Bauer, Geschäftsführer

I.V. Dirk Oestreich, Leiter Entwicklung

Diese Erklärung bescheinigt die Übereinstimmung mit den genannten Richtlinien, sichert jedoch keine Eigenschaften im Sinne des Produkt-  
haftungsgesetzes zu.

#### Geschäftsführer

HRB-Nr. 5890 Aschaffenburg  
Commerzbank  
Sparkasse Aschaffenburg  
Deutsche Bank

#### Sven Bauer

St. Nr.: 122/50444 Ust-ID-Nr.: DE 811770243  
BIC: COBADEFF795 IBAN: DE35795400490105770200BLZ: 79540049  
BIC: SYLDEM11ASA IBAN: DE7179550000240004283BLZ: 79550000  
BIC: DEUTDEFF508 IBAN: DE85508700050010501500BLZ: 50870005

Kto. 1057702  
Kto. 240004283  
Kto. 010501500

Figure 10-4: EC Declaration of Conformity ESS X

## 10.2 Installation check list

# Installation Checklist

## BMZ ESS Storage Products

Company name of installer (please use upper case letters)

--

Name, given name of installer

--

Street and housenumber

--

Postal code                      city of residence                      state

--	--	--

Telephone number (including area code)

--

E-Mail

--

Serial number of BMZ ESS energy storage device

S/N: 



 Art.Nr.: 



 -

Please fill in the checklist completely and send it to the battery manufacturer.

After a successful registration, the battery manufacturer gives a guarantee that exceeds the legal requirements.

“With my signature I confirm that I have received and read the operating instructions including the safety notes and installation instructions for the BMZ energy storage system. I confirm that I have successfully completed a BMZ training on the product BMZ ESS and received a certificate.

I accept the terms of warranty.”

Date

---

  
Signature of installer

- attach copy of invoice -

### Checklist for installer

Required Tools	Yes	No
The installer brings the following tools:		
• Allen wrench	<input type="checkbox"/>	<input type="checkbox"/>
• reversible ratchet VDE insulated with extension (VDE insulated)	<input type="checkbox"/>	<input type="checkbox"/>
• wrench socket (VDE insulated) size 13, 17	<input type="checkbox"/>	<input type="checkbox"/>
• Phillips screwdriver (VDE insulated)	<input type="checkbox"/>	<input type="checkbox"/>
• side cutter (VDE insulated)	<input type="checkbox"/>	<input type="checkbox"/>
• water pump pliers (VDE insulated)	<input type="checkbox"/>	<input type="checkbox"/>

Required protective equipment	Yes	No
The installer is recommended to bring the following personal protective equipment (PPE);		
• safety footwear class S3	<input type="checkbox"/>	<input type="checkbox"/>
• protective goggles	<input type="checkbox"/>	<input type="checkbox"/>
• safety gloves for electrically skilled persons	<input type="checkbox"/>	<input type="checkbox"/>
• eye wash bottle for emergencies	<input type="checkbox"/>	<input type="checkbox"/>
• fire extinguisher (ABC extinguishing powder)	<input type="checkbox"/>	<input type="checkbox"/>

Index 2
Installation Checklist BMZ ESS Storage Products

Figure 10-5: installation check list

# Installation Checklist

## BMZ ESS Storage Products



Required accessories	Yes	No
The installer is required to bring the following accessories or spare parts:		
<ul style="list-style-type: none"> <li>lifting carriage or hand truck with stair climbing function</li> <li>Multimeter (volt meter)</li> <li>NH1 fuse (depending on inverter with different nominal values)                             <ul style="list-style-type: none"> <li>SI3.0M-11: 80 A</li> <li>SI4.4M-11: 100 A</li> <li>SI6.0H-11: 160 A</li> <li>SI8.0H-11: 200 A</li> </ul> </li> </ul>	<input type="checkbox"/> <input type="checkbox"/> <input type="checkbox"/>	<input type="checkbox"/> <input type="checkbox"/> <input type="checkbox"/>
Checking installation location	Yes	No
Assembly space is okay		
<ul style="list-style-type: none"> <li>Distance to walls &gt; 20cm</li> <li>air circulation possible</li> <li>no ignition source &lt; 3m</li> <li>dry</li> <li>even</li> <li>clean</li> <li>no direct sunlight</li> </ul>	<input type="checkbox"/> <input type="checkbox"/> <input type="checkbox"/> <input type="checkbox"/> <input type="checkbox"/> <input type="checkbox"/> <input type="checkbox"/>	<input type="checkbox"/> <input type="checkbox"/> <input type="checkbox"/> <input type="checkbox"/> <input type="checkbox"/> <input type="checkbox"/> <input type="checkbox"/>
Checking for damage	Yes	No
Inspect packaging for transport damage (Never put a damaged battery into operation!)	<input type="checkbox"/>	<input type="checkbox"/>
Inspect battery for damage (Never put a damaged battery into operation!)	<input type="checkbox"/>	<input type="checkbox"/>
Checking installation	Yes	No
Cabling between inverter and battery is checked		
<ul style="list-style-type: none"> <li>2 pcs 50 mm<sup>2</sup> cables connected</li> <li>communication cable connected</li> <li>no short circuit</li> <li>no incorrect polarity of main cables (positive and negative)</li> <li>cables not damaged or destroyed</li> </ul>	<input type="checkbox"/> <input type="checkbox"/> <input type="checkbox"/> <input type="checkbox"/> <input type="checkbox"/>	<input type="checkbox"/> <input type="checkbox"/> <input type="checkbox"/> <input type="checkbox"/> <input type="checkbox"/>
Inserting NH fuses	Yes	No
NH1 fuse is inserted (see operating instruction or installation instruction)	<input type="checkbox"/>	<input type="checkbox"/>
Instructing the end customer	Yes	No
safety instruction for end customer is conducted	<input type="checkbox"/>	<input type="checkbox"/>
operating instruction for end customer is conducted	<input type="checkbox"/>	<input type="checkbox"/>
Reading the battery	Yes	No
Check the battery condition with the service software		
<ul style="list-style-type: none"> <li>System time is displayed correctly</li> <li>temperature memory is reset</li> <li>error memory is reset</li> </ul>	<input type="checkbox"/> <input type="checkbox"/> <input type="checkbox"/>	<input type="checkbox"/> <input type="checkbox"/> <input type="checkbox"/>
SMA parametrization	Yes	No
parametrization of SMA Sunny Island inverter is carried out	<input type="checkbox"/>	<input type="checkbox"/>
Putting system into operation	Yes	No
BMZ battery and SMA Sunny Island inverter are put into service	<input type="checkbox"/>	<input type="checkbox"/>

Figure 10-6: installation check list, part 2